

## Booth Regulations

### 04-1 Booth Standards

- 04-1-1 Booth Standards **Important**  
Exceeds Height Regulation
- 04-1-2 Standard Booth Facilities
- 04-1-3 Important Points for Booth Design **Important**  
Prohibition of usage of space beyond booth boundaries /  
Visibility of neighboring booths / In-booth stages /  
Speakers / Prohibition of using space other than within the booth
- 04-1-4 Ceiling Structure
- 04-1-5 Universal Design

### 04-2 Booth Display Regulations

- 04-2-1 Display Contractor Registration
- 04-2-2 Product Liability (PL) Law **Important**
- 04-2-3 Floor Work
- 04-2-4 Fireproofing Regulations
- 04-2-5 Electric Power  
Power Supply **Important**  
Electrical Work **Important**  
Power Activation
- 04-2-6 Green Power Certification System

### 04-3 Product Exhibit Regulations

- 04-3-1 Bonded Goods
- 04-3-2 Products for Exhibit
- 04-3-3 Display-Area lighting

### 04-4 In-Booth Demo Regulations

- 04-4-1 Prohibition **Important**  
Prohibition on Sales /  
Prohibition of Usage of Space beyond Booth Boundaries /  
Restriction on Smoke Effects
- 04-4-2 Sound Emissions and In-booth Demonstrations **Important**
- 04-4-3 In-booth Wireless LANs **Please cooperate**

### 04-5 Booth Management Regulations

- 04-5-1 Hazardous Item Handling
- 04-5-2 Exhibitors' Utility Booths (Storage)
- 04-5-3 Others **Important**  
Exhibition Hall Management and Insurance /  
Cancellation and Change of Exhibition Duration under  
Unavoidable Circumstances



**Booth Configurations**

- 1 row ..... (1, 2, 3, 4, 5, 6)
- 2 rows ..... (4, 6, 8, 10, 12)
- 3 rows ..... (9, 12, 15, 18)
- 4 rows ..... (16)
- Block format ..... (20, 25, 30, 35, 40, 45, 50, 55, 60, 65, 70, 75, 80, 85, 90, 95, 100)

**Booth Standards and Height**

**(1) Booth spaces for row booths**

**1. Booth Standards:**

One booth space: 2.97 m (w) 2.97 m (d).

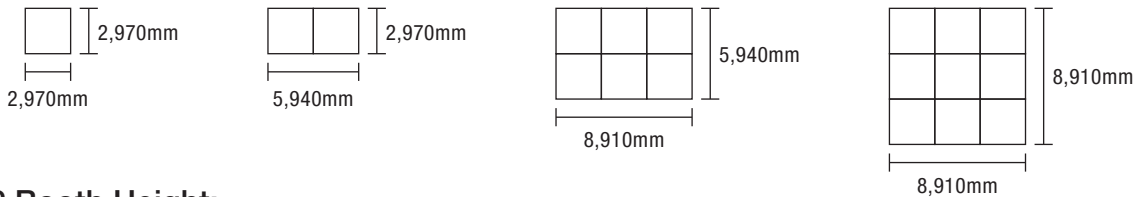

**2. Booth Height:**

The standard height is 2.7 m. The details of height of booth walls are shown below. The allowable height of group exhibit booth walls is same as those booths with 3 rows.

**● 1 row (1, 2, 3, 4, 5, 6)**

The allowable height of booth walls will be 3.6 m at set back 1.0 m from the corridors and / or foundation panels.

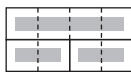

- ... Area where the hight is limited up to 2.7m or lower
- ... Area where the hight is limited up to 3.6m or lower

**● 2 rows (4, 6, 8, 10, 12)**

The allowable height of booth walls will be 3.6 m at set back 1.0 m from the corridors and / or foundation panels.

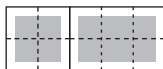

- ... Area where the hight is limited up to 2.7m or lower
- ... Area where the hight is limited up to 3.6m or lower

**● 3 rows (9, 12, 15, 16, 18)**

The allowable height of booth walls will be 3.6 m at set back 1.0 m from the corridors and / or foundation panels.

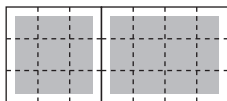

- ... Area where the hight is limited up to 2.7m or lower
- ... Area where the hight is limited up to 3.6m or lower

**(2) Booth spaces for block booths (20 or more)**

**1. Block booth standards.**

The standard for block booths is 1 booth space, 9m<sup>2</sup>. The floor will be marked in an area equal to 2:1 or 1:1 (w:d) based on the total floor space reserved (9 m<sup>2</sup> no. of booth spaces).

The actual dimensions will be provided to the exhibitors at the lot drawing for booth space allocation.

**2. Booth height of block format**

The overall allowable height will be 6m.



- ... Area where the hight is limited up to 6m or lower

### (3) In case the size of the product exceeds the booth specifications

The height limitation of exhibit products and decorations will be stipulated as above explained. Exhibitors are requested to submit "Application for Over-Regulated Heights" stating the necessary information to Japan Electronics Show Association by Friday, October 12, and attach product leaflet and diagram indicating location and height of product(s) (both floor plan and elevation drawing). In this case, the exhibited product should be displayed within the specified space limitation of the exhibition booth and cannot be displayed in a way that invades into the aisle. Exhibited product that has received prior permission to exceed the height limitation must be exhibited in the original state of the product itself, and any additional decoration will be prohibited.

#### ■ Height restrictions on the last row

Booths located in the final row (the topmost row on the booth allocation drawing) in the Exhibition Hall must take into account factors such as visibility by visitors and should adhere to the following height restrictions:

- Row booth (1 to 18 booth spaces): 4.5m (only the portion that has been set back 1.0m from the corridors)
- Block booth (20 or more booth spaces): 6m (all sides)

# Standard Booth Facilities

System panels are used as partitions between adjoining booths. The Management Office will not erect wall panels on the aisle sides of corner booths. However, exhibitors may erect their own wall panels or ask the Management Office to do so for additional charges.

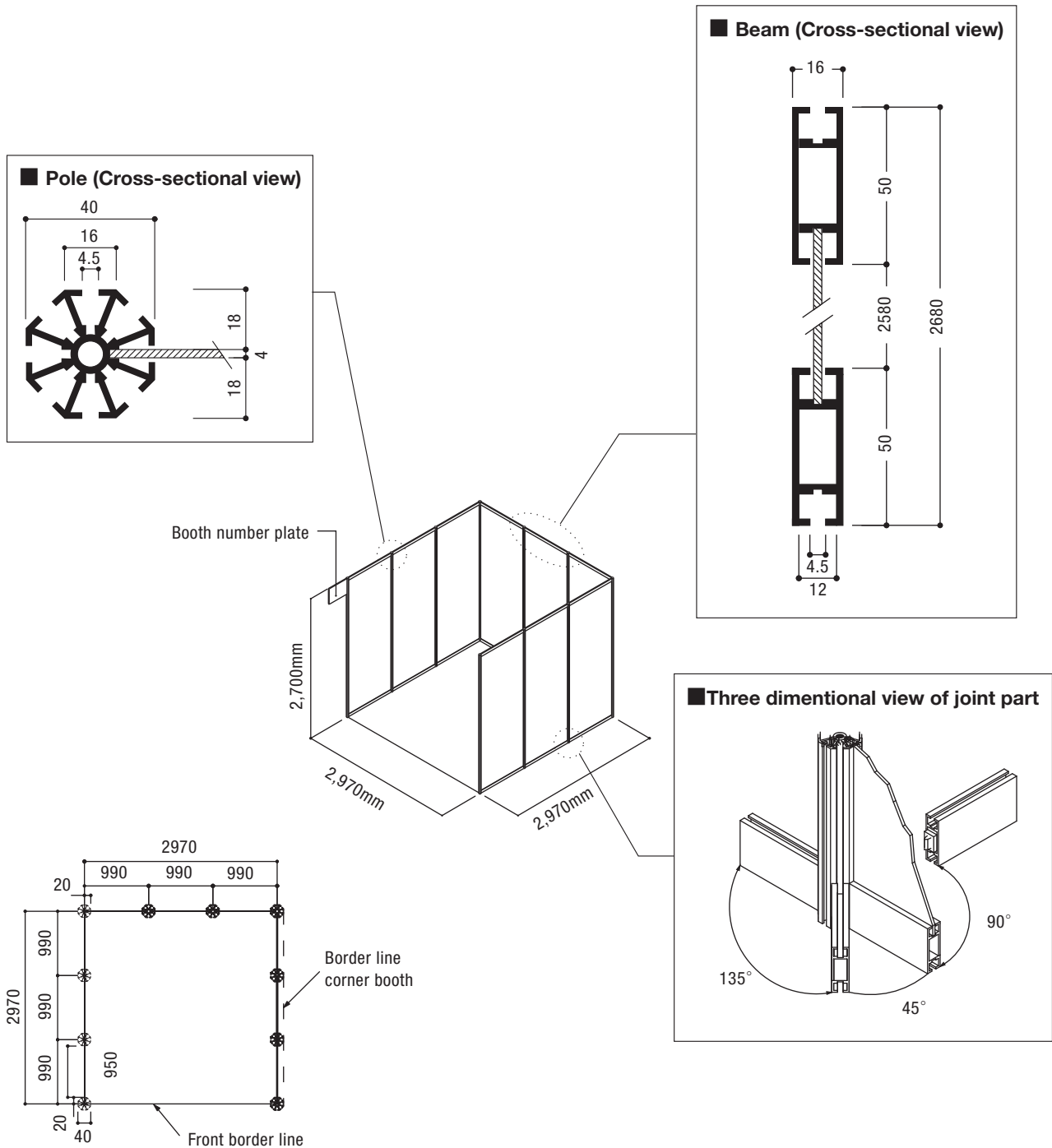

## Important Points for Booth Design

### ■ Prohibition of usage of space beyond booth boundaries

1. Exhibitors are responsible for controlling crowds around their booths, which might block aisles in public spaces. If a stage is set up in a booth, the Exhibitor must ensure that the booth layout makes it possible to bring all visitors inside the boundaries of the booth.
2. Inviting visitors and / or conducting surveys in aisles and / or public spaces is strictly prohibited.
3. Exhibits, decorations, fixtures, plants and packaging materials should not be left outside of booths, but must be stored within booths.
4. Directly lighting aisles, walls, ceilings, etc., of Makuhari Messe is strictly prohibited. Improvements will be requested to ensure that all booths conform to regulations. Failure to conform the regulations may result in the withdrawal of exhibiting privileges. All activities related to product display and / or demonstration should be conducted inside of the booths.

### ■ Visibility of neighboring booths

As for the design of independent booths, please take into consideration the positions of adjacent booths and design the booths in a way that enables visitors to get an unobstructed view of adjoining booths.

### ■ In-booth stages

Exhibitors planning to set up a stage in their booths must ensure that the booth layout makes it possible to bring all visitors inside the boundaries of the booth. If any problems occur in line with in-booth stages, the Management Office will request immediate countermeasures.

Good example

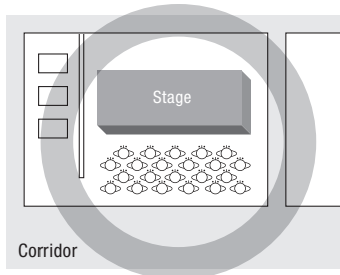

Bad example

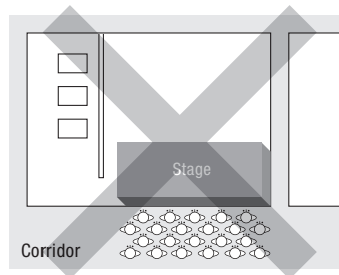

### ■ Speakers

Exhibitors are prohibited to set up public address systems, such as loudspeakers or mixers, directly facing neighboring booths. So as not to inconvenience visitors or neighboring booths, these systems must be positioned facing the stage. In case of installing loudspeakers on booth walls or displays fixture pillars, the central axis of each speaker must be 45 degrees or less. For details, please refer to the pictures below. If any problems occur in line with in-booth speakers, the Management Office will request immediate countermeasures.

Good example

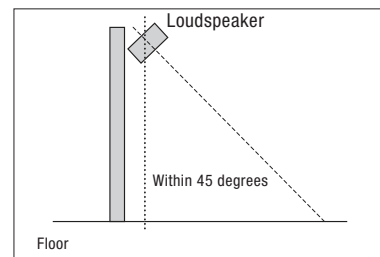
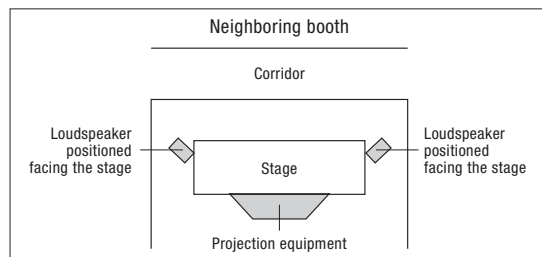

### ■ Prohibition of using space other than within the booth

- ① Visitors must not be allowed to block aisles around the booth. When setting up a stage or similar demonstration, ensure that the booth can accommodate a large number of visitors, if expected.
- ② Calling out to visitors from outside of the booth, having visitors fill out questionnaires outside of the booth, or similar activities are prohibited.
- ③ Product exhibits, fixtures, catalogs, equipment, plants, packaging materials cannot be placed in aisles around the booth or behind the booth.
- ④ Lighting directed toward aisles, exhibition hall walls or ceiling is prohibited.

## Ceiling Structure

---

### ■ Ceiling structure

Ceilings, either whole or partial, are prohibited. However, if ceilings are absolutely necessary for such reasons as to create shading, soundproofing, etc., they may be constructed with fireproof blackout curtains. The exhibitor must obtain permission from the local fire department. Direct sunlight can be shaded. However, it is possible that indirect rays of fluorescent light will reflect on TV monitors, etc., in booths. Please note that the Management Office will not take measures to prevent reflection. Exhibitors who wish to set up ceiling structure, are required to submit "Application for Ceiling Structure" to Makuhari Messe by Friday, October 12.

### ■ Two-story booth structures

Two-story structures are strictly prohibited.

### ■ Floor-lifting Structures

Booth floors may be raised a maximum of 1 meter.

### ■ Suspended Structure

Suspending decorations from the ceiling are prohibited.

## Universal Design

### ■ Universal Design (includes overseas visitors)

In order to provide services of a consistently high quality in line with the standards of the exhibition, Inter BEE has worked hard to raise overall satisfaction levels by seeking opinions and receiving requests from visitors. As we look ahead to the exhibition's role as a comprehensive forum worthy of participation from a diverse range of sectors, we will also strive to find ways of attracting numerous visitors. Please keep the following points in mind when considering booth design and operation. We would be grateful for your understanding and cooperation.

### ■ Requests to exhibitors for universal design

#### (1) Booth layout, furniture, and fixtures

- ◆ Spacious layout, and flow lines for visitors in wheelchairs
- ◆ Accessible booth without steps or slopes which may hinder visitors
- ◆ Arrangement of exhibits, panels, and signs
- ◆ Good visibility of signs and panels
- ◆ Multi-lingual panels for exhibits

#### (2) Service manner

- ◆ Multi-lingual guide staff
- ◆ Staff training on how to serve handicapped visitors
- ◆ Audio equipment with appropriate volume and direction

#### (3) Providing information in universal design

- ◆ Diverse means of providing information
- ◆ Multi-lingual leaflets

Exhibitors are asked to help make all visitors feel welcomed.

## Display Contractor Registration

---

To facilitate the management of operations, exhibitors are requested to submit the “Decoration Company Registration Form” to Murayama Inc. by Friday, October 12.

---

### ■ Compliance with rules

It is necessary for both the staff and contractor who are responsible for installations and decorations to fully understand and comply with all the regulations and contents contained in the Inter BEE exhibition manual. Please make sure to read the exhibition manual carefully.

---

### ■ Presenting forms

1. Exhibitors applying for small-package booth or package displays (appendix 05-2-1), will receive a “Decoration Company Registration Form” from Murayama Inc. and it must be completed.
2. For companies that will be doing its own installation, please enter the exhibitor’s name in the section of the decoration installation company.



# Product Liability (PL) Law

The Management Office recommends that exhibitors take the following countermeasures related to Japan's Product Liability (PL) Law.

## Safety / Alarm Indications

Exhibitors are strongly recommended to ensure the complete safety of their booths and provide adequate safety indications / alarm indications related to displays. The Management Office has designed its own serial safety indications / alarm indications. Exhibitors can download the PDF file at the Exclusive Exhibitor Page.

Color # for Safety / alarm indication

Red	DIC157
Yellow	DIC165
Black	K 100%

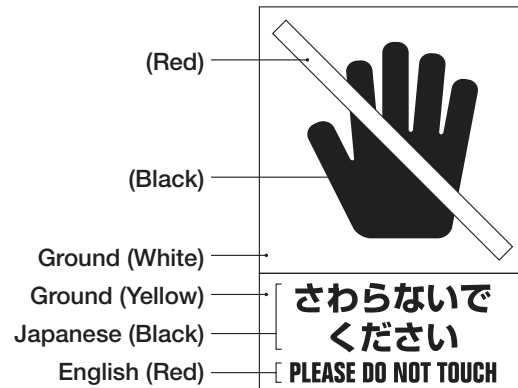
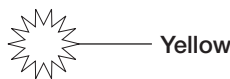

## Actual Usage Environment

Exhibits should be displayed in the same exhibition environment as that in which the exhibited products will be actually used. When designing and producing the booth, care should be taken to avoid giving visitors false expectations and/or generating misunderstandings regarding quality. If the exhibition environment is to be different from the actual usage environment, the exhibitor should clearly indicate this fact.

Exhibitors who require floor works are requested to submit the “Application for Floor Work” and 2 copies of the floor plan to Murayama Inc. by Friday, October 12.

### ■ Floor Work

1. Exhibitors are required to contact the Management Office in each hall before commencing the work and inform the number of anchor bolts to be affixed. (In case there is no need of anchor bolts, exhibitors are required to inform the cancellation)
2. Concrete nails and jackhammering are prohibited. No construction should be carried out on pit covers or pit interiors on the floors.
3. Restoration to original condition floor work is permitted on the condition that all flooring will be restored to its original state after the exhibition. After usage, if the bolt heads project above the surface, they must be sawn off, not hammered in or cut with acetylene torches. All expenses for restoration shall be borne by the exhibitor. In the event that the floor is not restored to its original condition after the final floor inspection, or the restoration is incomplete, the Management Office will complete the restoration work and charge its total expenses to the exhibitor after the exhibition.

【Use the hole-in anchor bolt】

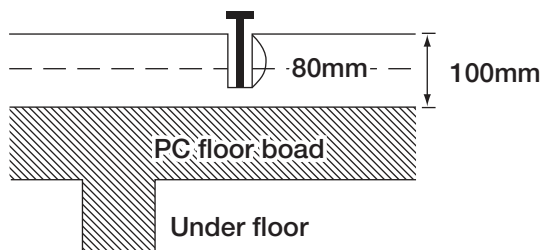

【Original condition】

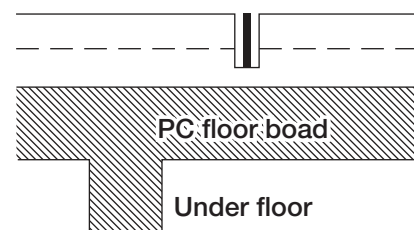

### ■ Floor restoration expenses

Exhibitors are required to pay the floor restoration fees regardless of the size of anchor bolts used.  
¥1,050 (including consumption tax) per anchor bolt

# Fireproofing Regulations

Inspections by the local fire department will be carried out during the display construction work of after its completion. Any work not in accordance with the below regulations may be suspended, or the structure(s) in question removed. Exhibitors are required to follow the instructions below.

## ■ Fireproofing Regulation

1. Any type of material, whether cloth or paper, affixed to plywood for display purposes should be fireproof.
2. Materials such as display mountings, artificial flowers, draperies, drop curtains, display plywood, fiber blinds, blackout curtains, carpeting or other flammable materials must be fireproof. Please attach a Fireproof tag to each of these materials in an easily visible location.
3. Avoid using paper flowers, urethane, acetate, polyester, nylon or other materials that are difficult to fireproof.
4. The use of plastic foam is prohibited. Please substitute Styrofoam or similar materials.
5. Fireproof labeling requirements are shown below.

## ■ Fireproof plywood

The background should be white. The *Kanji* characters 「防災」 (Fireproof) should be printed in red, and all other characters and horizontal lines should be in black. The fireproof indication located on the reverse side of fireproof plywood is shown below. Characters and lines should be red on this indication.

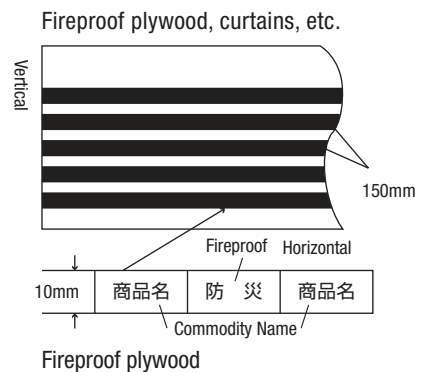

## ■ Fireproof carpet

The background should be white. The *Kanji* characters 「防災」 (Fireproof) should be printed in red, and all other characters and horizontal lines should be in black.

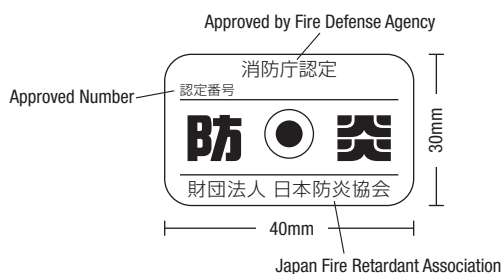

## Electric Power

To use electricity in the booth, enter the capacity in the “Application for Supply of Electricity” and submit it to the Shoho Denki Co., Ltd. by Friday, September 21, 2012. If you will be using a compressor, be sure to indicate the horsepower rating and make every effort to reduce noise to avoid disturbing other exhibitors. In addition, all exhibitors are required to submit the “Electrical construction Wiring Diagram” to Shoho Denki Co., Ltd. by Friday, October 12. The Management Office will then install the necessary number of switches based on this information. Enter all pertinent information as accurately as possible and please be aware that it may be impossible for us to answer requests on-site. Also, as this is the final confirmation document for electrical capacity, enter the capacity supply accurately and submit this form by the deadline.

### ■ Single-phase 100V and 200V facilities

The Show Management Secretariat will provide one 50Hz single breaker outlet at either 100V or 200V in each booth for demonstration and illumination of exhibits.

Please note that there are certain sections where cables cross through or in front of booths due to pit positions.

### ■ Power Capacity

An exhibitor is equipped with 1kW power capacity per booth at no extra charge. However, if required, extra power supply installation is available at a cost of ¥6,825 / kW(including consumption tax).

### ■ Triple-phase 200V facilities

Exhibitors can apply for installation of triple-phase 200V power, which is available at a cost of ¥6,825 / kW extra power supply (including consumption tax).

※The capacity required (watts) should be rounded up to the nearest thousand. (Example: 1.5kw→2kw)

### ■ Electrical work in booths

Exhibitors should carry out electrical construction work (in-booth power distribution boards, lights, fluorescent lights, outlets, etc.) using the circuit breaker installed by the Management Office. Exhibitors bear the responsibility to prevent accidents related to exhibits in booths through such measures as assigning a technician to be present at all times. In addition, circuit breakers must be installed on power distribution boards in each booth.

### ■ Power feed to booths

#### 1. Power feed availability

15 or more booths	From 10:00 a.m. Monday, November 12
12 or less booths	From 11:00 p.m. Monday, November 12

Please note that the power feed may be delayed depending on the progress of work in neighboring booths.

#### 2. The power feed will terminate at 5:15 pm on Friday, November 16, 2012.

#### 3. Miscellaneous information

If you require a power feed at an earlier date, 24-hour power, or continued power feed even after it is scheduled to stop, please submit the “Application Concerning Supply of Electricity” to the Shoho Denki Co., Ltd. by Friday, October 26. Additional charges will be applied for any earlier power feeds. Also, please be aware that scheduling may make it impossible to meet a request for an earlier power feed. If you want a 24-hour power feed, this requires a separate circuit. Basically, the exhibitor is responsible for managing and controlling the power supply for the company’s booth.

**■ Others****1. Protective equipment (backup)**

The Management Office cannot be responsible for any damage to exhibits caused by accidental power failure or voltage drops. For exhibits requiring constant voltage and/or frequency (the voltage in each booth will be 100V 5%), exhibitors are required to install necessary back-up equipment (power supply stabilizing units, etc.).

**2. Electrician licensing**

Contractors carrying out electrical work in booths must carry their licenses with them at all times. Unlicensed workers or those who fail to carry their licenses will be ordered to stop work.

**3. Observing electrical standards**

Electrical work in each booth must be carried out in accordance with electrical standards (internal electrical regulations).

# Green Power Certification System

You can publicize your CO<sub>2</sub> reduction measures / contribution to environmental protection at your exhibition. If you wish to participate in this program, please submit your “Application for Certification of Green Power” to the Japan Electronics Show Association by October 12. The issues of prevention of global warming, environmental protection, and CSR are becoming more and more important these days and natural energy has an important role to play. But, it is very difficult for companies to own power generation equipment based on natural energy sources. However, there is a system in which you can entrust power generation based on natural energy sources to someone else and can receive “Certification of Green Power” for environmental added value created by that power generation. Please utilize this program to publicize your CO<sub>2</sub> reduction measures / environmental protection measures at your exhibition booth.

## What is Green Power ?

It means power generated by natural energy resources such as solar power, wind, biomass.

## How does Certification of Green Power work ?

Certification of Green Power is a certificate for environmental added value (CO<sub>2</sub> emission reductions, reduction of fossil fuels) of power generated by natural energy sources. Electricity you use through purchasing Certification of Green Power will be considered electricity derived from natural energy sources.

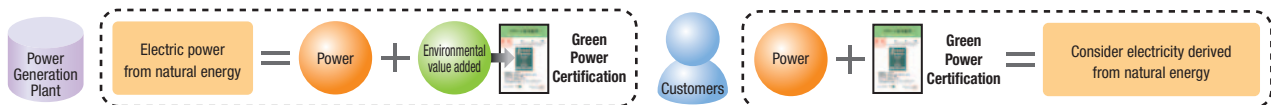

## Contracts and Fees regarding the use of Certification of Green Power

Term of Contract: From the delivery start date to the end of Inter BEE

Contracted Amount: 1,000kWh unit

Unit Price: From 10,000 yen per 1,000kWh plus certification issuance fee of 5,000 yen

How to calculate usage fees: The amount of electricity used (kW) × Hours of Use (h)

Here are the standards for the hours of use

More than 15 booths	37 hours
Less than 12 booths	32 hours

Example of Calculation:

When the estimated amount of electricity used is 10kW and the number of booths is 6  
**10kW × 32h = 320kWh**

Contract Amount: 10,000 yen~ Certification Issuance Fees: 5,000 yen Total: 15,000 yen~

## Issuance of Certification of Green Power

We will issue a Certification of Green Power approximately 2 weeks after contracting. We will provide you with Green Power mark data upon contracting. You can publicize your usage of green power by indicating the marks below on materials distributed at your booth or your website.



Example 1: ●●kWh of electricity used at this booth uses green electricity based on Green Power.

Example 2: As we exhibit at “InterBEE 2012”, we are promoting the use of natural energy sources by purchasing ○○kWh of Green Power to be used at our booth.

Provided by Japan Natural Energy Company Limited

## You will have to contract with Japan Natural Energy Company Limited after application.

Japan Natural Energy Company Limited

Rinsan-club Building 4F, 3-1-6 Nihonbashi-muromachi Chuo-ku Tokyo 103-0022 Japan Tel: +81-3-3510-0351 Fax: +81-3-3510-0350 <http://www.natural-e.co.jp>

## Bonded Goods

### ■ Bonded Exhibition

For exhibitors planning to bring foreign-made goods and / or exhibition materials to Inter BEE, the Management Office will apply to Japanese customs authorities for approval of the exhibition as a bonded exhibition. With this authorization, foreign-made goods (goods manufactured and / or assembled outside of Japan, for which import and customs procedures have not been completed) can be brought to the exhibition site under bonded status.

### ■ Bonded Exhibition Goods

Because bonded exhibition goods will be treated as pre-import goods, they will be under the management of the customs authorities of Japan. As such, methods of transporting and handling said goods must be approved in advance by customs authorities. All packages used to transport bonded exhibition goods will also be under the management of customs authorities, even when empty. Goods excluded from bonded status include catalogs, pamphlets and other goods that will be distributed to visitors or are considered consumables. Exhibitors planning to bring in such goods must receive import approval before delivering said goods to the exhibition site.

### ■ How to Apply

Exhibitors planning to bring in bonded exhibition goods are required to fill in the necessary information on the Foreign-Made Product Exhibition Plan and submit it to Ishikawa-Gumi by Friday, August 10. This form refers to planning documents for bonded exhibitions to be submitted to the Yokohama Customs Office, so changes to exhibited items will be permitted during the exhibition. The Management Office has authorized Ishikawa-Gumi, Ltd. to make all customs and transport arrangements for bonded items. For more details about bonded items, please contact Ishikawa-Gumi directly.

Contact:  
Ishikawa-Gumi, Ltd  
Person in charge: Ms. Hasegawa, and Mr. Saito at International Dept.  
5-9-4, Higashi-shinagawa, Shinagawa-ku, Tokyo 140-0002  
Tel: +81-3474-8102 Fax: +81-3-5460-9841  
e-mail: [igl-exhi@ishikawa-gumi.co.jp](mailto:igl-exhi@ishikawa-gumi.co.jp)

## Products for Exhibit

---

The Management Office documents information on exhibited products such as whether they were made outside of Japan, their original manufacturer, etc., to obtain the approximate number of exhibitors participating. Therefore, please submit the “Notification Form for Exhibited Products” to the Japan Electronics Show Association by Friday, October 19. Thank you in advance for your cooperation on this matter.

### ■ How to fill out the form

If any of the following items apply to your exhibit products, please inform the management office of the manufacturers' name.

1. Exhibitors with headquarters located in Japan.

Products other than in-house products.

2. Exhibitors with headquarters located outside of Japan (exhibiting products via its Japan office).

In-house products manufactured in the country where the headquarters is located.

Products other than in-house products.

Note: Submit the form even when exhibiting in-house products made in Japan.



## Display-Area lighting

### ■ Display-area Lighting

Four high-pressure mercury-arc lamps per display block generate brightness 500 lux in Full lighting Area and 50 lux in Lights off area. However, considering the display environments in each hall, the following lighting plan will be implemented by the Management Office.

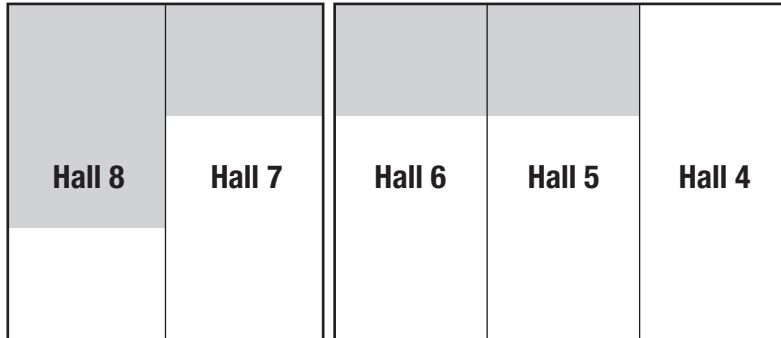

- Lights off
- Full lighting

### ■ Test for lighting adjustment

Lighting adjustment plans to be implemented from 2:00 p.m. to 4:00 p.m. on November 13.

We are going to pull down the shutter in South Side during the testing overhead lighting. Please go through from the north part during the testing time. Some areas of the site have natural lighting; please bear in mind that intensity may vary according to the weather, the booth lighting, or the color of the booth wallpaper.

## Prohibition

### ■ Prohibition on Sales

No exhibit materials are allowed to be sold during the exhibition period for any reasons. Exceptions will be products exhibited in the Service and Software category, and related products.

### ■ Prohibition of Usage of Space beyond Booth Boundaries

1. Exhibitors are responsible for controlling crowds around their booths, which might block aisles in public spaces. If a stage is set up in the booth, the exhibitor must ensure that the booth layout makes it possible to bring all visitors inside the boundaries of the booth.
2. Inviting visitors into booths and / or conducting surveys in aisles in public spaces is strictly prohibited.
3. Exhibits, decorations, fixtures, plants and packaging materials should not be left outside of booths, but must be stored within booths.
4. Directly lighting aisles, walls, ceilings, etc., of Makuhari Messe is strictly prohibited.

Improvements will be requested to ensure that all booths conform to regulations. Failure to conform may result in the withdrawal of exhibiting privileges.

### ■ Restriction on Smoke Effects

Smoke effects (including dry ice, carbon dioxide gas, etc.) are prohibited.

## Sound Emissions and In-booth Demonstrations

### ■ Sound Volume

When using AV equipment for a demonstration and / or explanation in a booth, exhibitors are requested to follow the instructions below in order to keep comfortable environment for visitors.

Sound Level : less than 75dB

1. Above sound volume is the standard, when measured from 2 m away from the border line of booth. This level must be observed throughout every booth.
2. During the exhibition period, the Management Office will regularly measure sound levels. Exhibitors are also asked to voluntarily measure sound levels within their booths before and during the exhibition. Contact the on-site Management Office to borrow measuring equipment.
3. Breach of noise-level restrictions: Any exhibits exceeding the specified noise levels must be modified to conform to regulations. Failure to conform may result in the loss of exhibiting privileges.
4. Regardless of these regulations, if complaints are received from neighboring exhibitors or noise is noticeable in other areas of the site, the Management Office will require the exhibitor in question to lower noise levels to guarantee a comfortable environment for all visitors and exhibitors.
5. Exhibitors are requested to pay sufficient attention to the locations and directions of loudspeakers or mixers. (See page 04-1-3)

### ■ Copyrights

Exhibitors playing music or replaying recorded audio or video material must pay royalties on said material (unless the exhibitor owns the rights or has made separate arrangements for payment of royalties). Royalties are payable to the Japanese Society for the Rights of Authors, Composers and Publishers (JASRAC), which handles royalties in Japan. Please contact JASRAC at the following address for details on arrangements and royalty calculation methods. For inquiries about video copyright, please directly contact the corporation or group that made the video.

Japanese Society for the Rights of Authors,  
Composers and Publishers (JASRAC)  
Tokyo Event & Concert Division  
10fl. Nihon Seimei Shinjuku Nishiguchi Bldg.  
1-17-1, Nishi Shinjuku, Shinjuku-ku, Tokyo 160-0023, Japan  
Tel: +81-3-5321-9881 Fax: +81-3-3345-5760

### ■ Illumination / Lighting

Nothing may be directly attached, nor may lights be shone directly onto the walls, floors or ceiling of exhibition hall except for the Professional Lighting Equipment zone.

When strong lighting equipment such as LEDs are used in displays and/or signboards, they must be positioned so as not to inconvenience visitors or neighboring booths. If any problems occur in line with lighting, the Management Office will request immediate countermeasures.

### ■ Others

Please take preventive measures to avoid the generation of the following during demonstrations. Please be considerate of other exhibitors and visitors.

1. Hot air
2. Gases
3. Odors
4. Vibration

## In-booth Wireless LANs

The increasing use of wireless LAN for demonstrations and the like in recent years has caused interference with adjacent booths. This is to avoid communication problems due to channel interference and / or SSIDs in neighboring booths by adjusting channels in advance. Exhibitors planning to connect wireless LANs in their booths are required to submit an "Application for In-booth Wireless LAN" to Makuhari Messe by Friday, October 26.

### ■ Before sending the application

1. Exhibitors planning to use equipment compatible to IEEE 802.11b , IEEE 802.11a and IEEE 802.11g standards are required to submit the application.
2. Exhibitors planning to connect wireless LANs and falling under (i) above, regardless of the type of AP (access point), wireless LAN card, PC with wireless function installed or other equipment, are required to submit the application.
3. Exhibitors are responsible for making arrangements for equipment and Internet connections.
4. If neighboring booths plan to use same channel, the Management Office will ask one or both to use different channels. For this reason, the Management Office cannot guarantee that every exhibitor will be able to use the channel it specifies in the application.
5. In case applying more than one channel, the Management Office may limit the number of channels to provide depending on circumstances.
6. Wireless LAN standards limit the number of channels available, and channels will be awarded on a first-come-first-served basis. Exhibitors submitting the application after the submission deadline might not be able to use a wireless LAN.
7. It is possible that channel adjustment may cause interference with the channel you have been allocated. We recommend that you have a cable system ready as backup in the event that interference affects your wireless LAN.
8. Information on wireless LAN channels will be provided to exhibitors one week before the exhibition begins.
9. This application is only to apply for a wireless LAN in your booth, not including Internet connection order placement. If you wish to use Internet, the Application for Internet Connection should be submitted separately.
10. This application does not include wireless microphone channel adjustment. Wireless microphone adjustment should be arranged among the exhibitors involved.

## Hazardous Item Handling

### ■ The Fire Prevention Law Prohibits the Following Activities on the Exhibition Site

1. Smoking
2. Open flame (spark-producing items, exposed elements, etc.)
3. Liquefied petroleum gas (LPG) or other flammable / pressurized gases
4. Hazardous objects (gasoline, kerosene, other oils, etc.)
5. Hazardous materials (explosives, matches or disposable lighters in large quantities, etc.)

### ■ Exceptions

The permission for bringing-in of the items above may be obtained from the local fire department. Therefore, the exhibitors who need any of the above mentioned materials (except smoking) to execute product demonstrations are required to submit the "Application for Flammable or Hazardous Materials Use" and two copies of detailed descriptions for the demonstrations to Murayama Inc. by Friday, October 12.

### ■ Smoking

Smoking in the booths is strictly prohibited. Smoking is only permitted in specially designated Smoking Areas.

### ■ Open Flame

The Exhibitors must to follow the conditions below when they use open flame:

1. Minimize possible the size and quantity of on-site equipment and use devices of the same type.
2. Protect the surrounding area with fireproofed materials.
3. Observe conditions closely and provide adequate fire safety equipment.
4. Set up one fire extinguisher. Provide one fire extinguisher (Type 10 and above) with an extinguishing capacity of 2 or higher.
5. Responsible person must be stationed at the booth.
6. Open flame must be at least 5 m from fire exits, hazardous materials and other flammable materials.

### ■ Liquefied Petroleum Gas (LPG) or Pressurized Gas

The exhibitors must to observe following rules when using LPG and other pressurized gases (oxygen, hydrogen, nitrogen, carbon dioxide, argon gas, etc.):

1. After installation, test all containers for leaks, and if necessary display a sign says, "Caution: Do Not Use Near Flammables" on them.
2. Use pressurized gases under the lowest possible pressure, and handle containers carefully. Bringing in of flammable gas cylinders (except cartridge types) to the exhibition site is strictly prohibited.
3. To prevent gas leakage, use a complete connector for all connecting parts and check continuously with a gas leak detector.

### ■ Hazardous Materials

1. Bring only one day's supply or less onto the exhibition site.
2. Do not replenish supplies during exhibition operating hours.
3. Provide adequate fire safety measures and handle materials carefully at all times.
4. Place hazardous materials 6 m and other materials 3 m or more from emergency exits.
5. A Type 10 fire extinguisher must be readily available.
6. Place hazardous materials 5 m away from areas in which open flames are being used.
7. Responsible person must be stationed at the booth to monitor safety.

## Exhibitors' Utility Booths (Storage)

Exhibitors who require utility booths are requested to submit the "Application for Exhibitors' Utility booths" to Japan Electronics Show Association by Friday, September 7.

### Utility booths locations

The location of exhibitors's utility booths will be considered by the Management Office.  
Please note that the location of the storage rooms cannot be decided by the exhibitors.

### Usage period

Utility booths will be available for use from 1:00 p.m., Monday, November 12 to 6:00 p.m., Friday, November 16.

### Key rental

The Show Management Secretariat will start renting keys on Monday, November 12.  
Exhibitors are requested to bring their business card and pick up their keys at the on-site management office.  
Returning of the key : Please return the key to the Management Office by 6:00 p.m., Friday, November 16.

### Regular Type

Size: (W) 2.97m × (D) 2.97m × (H) 2.7m  
(both Type A and Type B)

#### • Type A

**¥210,000, including consumption tax**

includes 3 folding chairs, 1 long table, 1 three-person locker,  
2 sets of steel shelves, 2 fluorescent lights and 1 electricity outlet.

#### • Type B

**¥189,000, including consumption tax**

includes 2 fluorescent lights and 1 electricity outlet.

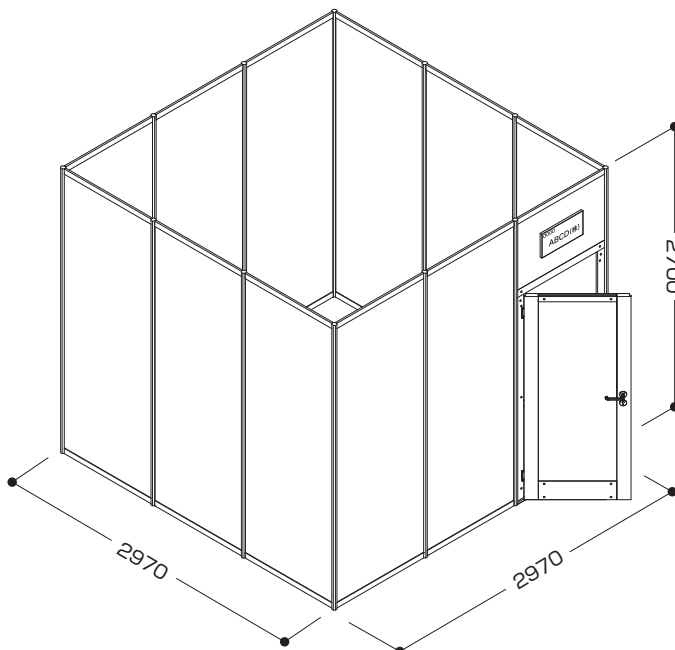

### Small Type

Size: (W) 2m × (D) 2m × (H) 2.7m

Price:

**¥115,500, including consumption tax**

includes 2 fluorescent lights and  
1 electricity outlet.

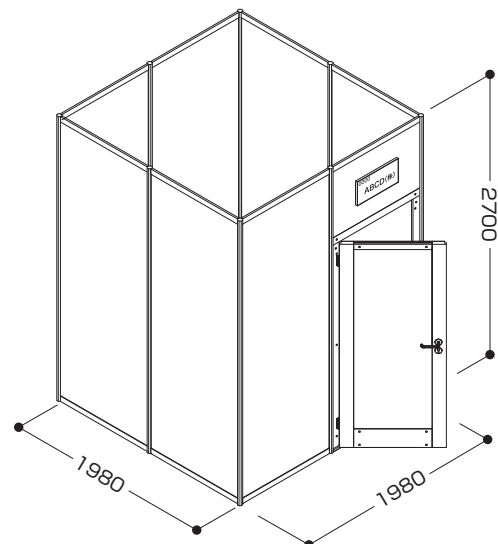

### ■ Exhibits/Demonstrations

The Management Office is responsible for the management, maintenance, preservation of order and safety of visitors. Exhibitors may be requested to take suitable countermeasures when it is deemed they impede these responsibilities, or a demonstration might have to be altered or canceled. The Management Office will not be held responsible for accidents caused by exhibitors. If there is an accident, the exhibitor should take immediate measures and contact the Management Office.

### ■ Exhibition Hall Management and Insurance

1. The exhibition management will, to the best of its ability, provide for the security of exhibits during the show period, for example, by implementing security guard patrols. However, the management cannot assume responsibility for damages from natural disaster, fire, theft, loss of property or other occurrences beyond its control and recommends that exhibitors take steps of their own.
2. Exhibitors must make immediate reparations in the case of injuries and / or property damage occurring at the exhibition site, whether or not said injuries / damage result from negligence on the exhibitor's part. A booth manager should be on hand at all times to prevent injuries, damage, fire and other hazards that might occur during demonstrations.
3. Exhibitors are encouraged to arrange appropriate measures, such as insurance, for their property at the exhibition. Please contact Toho Agency Co.,Ltd. which is handling all insurance-related matters, for details.

**Toho Agency Co.,Ltd.**

**Contact: Kayano, Ogawa**

**Chiba 5F Nipponkoa Bldg., 8-4 Chibaminato, Chuo-ku, Chiba 260-0026, Japan**

**Tel: +81-43-246-1441 Fax: +81-43-246-9704**

### ■ Cancellation and Change of Exhibition Duration under Unavoidable Circumstances

1. Neither the exhibition organizers nor sponsors shall assume any responsibility if the exhibition is canceled because of an unavoidable calamity or potential calamity, such as an earthquake, fire, disease, terrorist act or order from the public authorities.
2. If an unavoidable calamity prior to the opening of Inter BEE forces exhibition cancellation, participation fees paid by exhibitors will be refunded in full, minus a charge for expenses already incurred.
3. Neither the exhibition organizers nor sponsors shall be held liable to refund either full or partial exhibition expenses if the exhibition duration is unavoidably shortened because of a calamity or potential calamity.
4. The Organizer assumes no responsibility for other expenses already incurred by exhibitors.