

From the Management Office

01-1 Exhibition Regulation

01-1-1 Exhibition Outline

01-1-2 Inter BEE 2012 Exhibition Regulations

01-2 Safety Measures

01-2-1 Basic Policy and Organizational Framework concerning Disaster Prevention and Safety Measures **Important**

01-2-2 Requests to Exhibitors Concerning Disaster Prevention and Safety Measures **Important**

01-2-3 Exhibitors' Response to an Emergency **Important**

01-2-4 Disaster Evacuation Route **Important**

01-2-5 Emergency Drill **Important**

01-3 Emergency Conservation Measures

01-3-1 Requests to Help Save Energy **Important**

01-4 Personal Information Protection Law

01-4-1 Personal Information Protection Law **Important**

01-4-2 Use of Personal Information by Exhibitors **Important**

01-5 Inquiries List

01-5-1 Payment of Charges **Important**

01-5-2 Inquiries List **Important**

01

Exhibition Outline

■ Name	International Broadcast Equipment Exhibition 2012 (Inter BEE 2012)
■ Period	Wednesday, November 14 – Friday, November 16, 2012 (3 days)
■ Exhibition Hours	November 14 and 15: 10:00 a.m. to 5:30 p.m. November 16: 10:00 a.m. to 5:00 p.m.
■ Location	Makuhari Messe Exhibition Halls 4, 5, 6, 7, 8 2-1, Nakase, Mihama-ku, Chiba City, Chiba Prefecture 261-0023, Japan
■ Admission	Free (Registration system)
■ Organizer	JEITA Japan Electronics and Information Technology Industries Association
■ Supported by	Ministry of Economy, Trade and Industry, Japan (METI) Japan Broadcasting Corporation (NHK) The National Association of Commercial Broadcasters in Japan (NAB) Association of Radio Industries and Businesses (ARIB)
■ Partners	ALL NIPPON PRODUCERS ASSOCIATION Association of Media in Digital Camera & Imaging Products Association Digital Cinema Consortium of Japan Digital Content Association of Japan Digital Signage Consortium IPDC Forum JAPAN AD CONTENTS PRODUCTION COMPANIES ASSOCIATION Japan Association of Audiovisual Producers, Inc. Japan Association of Lighting Engineers & Designers Japan Association of Professional Recording Studios Japan Audio Society Japan Cable and Telecommunications Association Japan Cable Television Engineering Association JAPAN POST PRODUCTION ASSOCIATION Japan Satellite Broadcasting Association JAPAN STAGE SOUND BUSINESS COOPERATIVE Japanese Society of Cinematographers JSL Mobile Broadband Association MOTION PICTURE and TELEVISION ENGINEERING SOCIETY of japan, Inc. National Theatrical & Television Lighting Industrial Cooperative Specified Radio microphone User's Federation Stage Sound Association of Japan The Association of Japanese Animations Theatre and Entertainment Technology Association, Japan 3D Consortium Ultra-Realistic Communications Forum VFX-JAPAN Visual Industry Promotion Organization
■ Managed by	Japan Electronics Show Association (JESA)

Inter BEE 2012 Exhibition Regulations

1. Exhibitor eligibility / booth details

1-1. Exhibitor eligibility

Corporations and organizations involved with products included in the following list or related businesses are eligible to participate in Inter BEE:

- Equipment manufactures
 - Electronic components, devices, and materials manufacturers
 - Broadcasting and communications companies
 - Software and content production companies
 - Trading and distribution companies
 - Service companies
 - Newspapers, magazines and other publishing companies
 - Educational and research institutes
 - Government organization, administrative corporations, public-interest corporations,
 - non-profit public and industry organizations
 - Members of the sponsoring organization (JEITA) are also eligible to participate.
- (1) Advertising companies and other related agencies are not allowed to represent any company that exhibits products even if said products are included in the aforementioned list of eligible businesses or products.
- (2) The Organizing Committee reserves the right to refuse applications from companies that have violated regulations at a previous show or whose activities may be considered detrimental to visitors and/or other exhibitors regardless of in prior to or after holding an exhibitor contract. In such case, paid booth fees will be refunded. (see section 2-4: Exhibit application and contract agreement)

1-2. Exhibits

All types of equipment, accessories, measuring units, components and software used for broadcasting and program production.

Professional Audio Equipment

■ Audio Equipment

Microphones, Recorders, Digital Audio Workstation, Consoles, Mixers, Mastering Equipment, Audio-compression/Transmission technology, Converters, Effectors, Amplifiers, Processor, Equalizer, Interface, Speakers, Players, Audiometer, Loudness-related Equipment, Acoustic design/control, Audio Equipment for Movie Theater and, Commerce Facility, PA system, Live Sound System, Professional, Electronic Musical Instruments, Computer Sound System, Headphones, Headset, Intercoms, Transmission Cables, Accessories, Power Supply, Racks/Cases/Bags, Other Related Peripheral Equipment

Professional Lighting Equipment

■ Lighting Equipment

Studio Lighting Equipment, Stage Lighting Equipment, TV Studio Lighting Equipment, Film and Video Lighting Equipment, Lighting System for Photography Studios, Lighting Control Systems, Lighting Control Board, Console, Dimmer, Wireless Remote Control Devices, Effect Lighting Equipment, Searchlight, Large-scale effect lighting, Projectors, Projection Mapping, Video Mapping Techniques, LED, Strobe Lights, Elevating Unit for TV Studio Lighting Batters, Wiring Device, Cables, Other Related Peripheral Equipment

Video and Broadcast Equipment

■ Production

- Cameras and Related Equipment
 - HDTV Systems, Studio Cameras, VTR-Pack Cameras, Camcorder, 4K Cameras, Digital Cinema Cameras, 3D Cameras, Crane Cameras, Lenses, Other Related Peripheral Equipment
- Recording Equipment
 - Video Servers, File Server System, DVD Systems, BD Systems, VTRs, Memory Cards, Memory Devices, Optical Disks, Video Tape, Data Compression Technology, Other Related Peripheral Equipment
- Electronic Displays
 - Video Monitors, Multiple Monitor Displays, Projectors, LCD/PDP/LED/OLED Displays, Promoters, Other Related Peripheral Equipment

■ Post-production

- Editing and Production Equipment
 - Editing Devices, Switchers, Routing Switchers, Non-linear Editing Systems, Visual Effects, Color Correction, Painting Systems, Subtitled, Title Production Systems, Character Generators, Composite Systems and Software, Media Converter, Encoders, Other Related Software and Peripheral Equipment
- Multimedia Systems
 - CG Production Systems, Animation Production Systems, Virtual Studio Systems, Motion Capture Systems, Software and Systems, Other Related Software and Peripheral Equipment
- Production Management Systems
 - Content Management Systems, Systems Integration Technologies, Database Technologies, Storage Equipment, Archive Systems, Other Related Software and Peripheral Equipment

■ Output and Transmission Systems

- Output Systems
 - Automatic Program Output Systems (TV&Radio), Automatic CM Output Systems(TV&Radio), Server Systems, IT Solutions (Broadband Systems), File Systems (Audio), File Systems (Video), Graphic Libraries Systems, Film and Telecine, Graphic Systems, External Information Response Systems (Weather, Stock, Traffic information etc.), Other Related Peripheral Equipment
- Relay Systems
 - Base Station Facilities, FPU's, SNG, OB Van, Automotive Related Systems and Peripherals, Communications Radios, Emergency News Systems, Other Related Peripheral Equipment
- Transmission Systems
 - Terrestrial Television Broadcasting, One-segment Broadcasting, White Space, One-segment local service, V-High and V-Low Band, Multimedia Broadcast, Radio Broadcasting Equipment, FM Broadcasting Equipment, Satellite Broadcasting, Cable Television, Video Delivery Networks, CDN, Transmission Cables, Wireless Systems, Fiber Optics, Other Related Peripheral Equipment

■ Broadcasting Equipment

- Electric Power Units
 - No-break Power Units, Constant-Voltage, Constant-Current Regulated Power Units, Automotive Power Sources, Battery Packs, Battery Charger-Discharger Equipment, Other Related Peripheral Equipment
- Measuring Equipment and Converters
 - Test Signal Generators, Measuring Equipment, Signal Converters, Other Related Peripheral Equipment,
- Stand-by and Peripheral Products
 - Cabinets, Racks, Pedestals, Camera Tripods, Camera Platforms, Cranes, Steadycams, Furniture, Camera Carrying Cases, Other Related Peripheral Equipment
- Design, Development and Manufacturing for Broadcast Equipment
 - Development Languages, Semiconductors, Components, Development, Manufacturing, Studio System Design, Construction, Maintenance, Dispatched Engineers

■ Publications / Publicities

Related Books, Music Libraries, Related Software/Services, Consulting Services

Cross-media

■ IPTV/ Internet Delivery

Video Compression Techniques, Video Editing/Control Systems, Video Delivery Systems/Services, Data Broadcasting Systems, Video-on-demand Systems, Internet Broadcasting System, Software, Other Related Techniques/Products/Services

■ Mobile TV

Video Editing Systems For Mobile, Video Delivery Systems For Mobile, Mobile Contents/Applications, Mobile Terminal Equipment, Wireless Systems, Wi-Fi/WiMax, LTE, Other Related Techniques/Products/Services

■ Digital Cinema

Digital Cinema Filming Systems, Digital Cinema Editing Systems, Digital Cinema Delivery Systems, Digital Cinema Servers, Projection Systems, On-demand Services/Contents, Other Related Techniques/Products/Services

■ Digital Signage

Digital Signage Editing/Control Systems, Image Receiving Systems, Video Content Delivery Systems, Communication Network Services, Advertising Media Services, Other Related Techniques/Products/Services

■ 3D Image

3D Image Output Systems, 3D Image Editing Systems, 3D Image Receivers/Terminals/Systems, 3D Screening Systems, 3D Contents, Other Related Techniques/Products/Services

■ Next-generation Video Technology

4K, 8K Displays, Glasses-free 3D Technology, Motion Sensor System, Interactive Systems, Virtual Realities, Augmented Reality, Panoramic Image, High-Definition Surveillance Video Systems, High-Definition Medical Image Systems, Other related techniques/products/services

■ Digital Contents

Live-Action Contents, Animations, Computer Graphics, Other Related Techniques/Products/Services

Inter BEE 2012 Exhibition Regulations

1-3. Exhibition categories

Professional Audio Equipment Zone	full overhead lighting only
Professional Lighting Equipment Zone	all overhead lighting off only
Video and Broadcast Equipment Zone	either full overhead lighting or all overhead lighting off can be selected
Cross-media Zone	full overhead lighting only

When an item to be exhibited falls into both categories, two options are possible: the exhibit may either be placed in the category of greatest importance, or the exhibitor may exhibit in both categories. If the Video and Broadcast Equipment Category is selected, the exhibitor may choose to have all overhead lighting on or off. In addition, exhibitors in the Professional Lighting category may illuminate towards the ceiling; however, considering the influence on surrounding exhibitors, please note that this kind of exhibitors' booth will be located at the far end of the show space.

1-4. Booth standards, specifications and description

1. Standard Booth

- (1) 1 to 4 row booths & Facilities (1 to 18 booth spaces)
 - a. Booth space : 2,970mm(W) x 2,970mm(D)
 - b. Specification :

For exhibitors with 1- to 4-row booths, system panels will be installed as back panels on the sides neighboring booths of other exhibitors. However, system panels will not be placed on the corner-facing sides of corner booths.

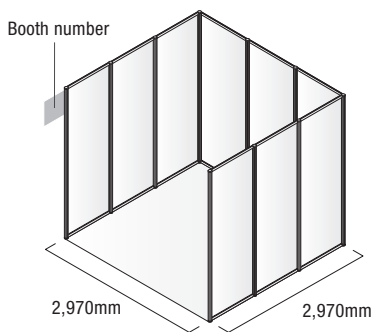

(2) Block booths (20 or more booth spaces)

The standard for block booths is: 1 booth space = 9 m². The floor will be marked in an area equal to (W:D) 2:1 or 1:1 based on the total floor space reserved (9 m² x no. of booth spaces). The actual dimensions will be provided to exhibitors at the lot drawing for booth space allocation.

[Sample booth dimensions]

Example of an application for 25 booth spaces: Dimensions are marked out for an area of 225m² (9m² x 25 booth spaces), ranging from a rectangular shape with a wider entry dimensions than a square.

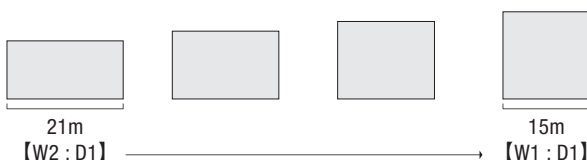

(3) Booth height limitations

The standard height is 2.7m. Details of booth wall heights are shown below.

a. 1 to 18 booths(row-type booth)

The allowable height of booth walls set back 1.0m from the corridors and / or foundation panels will be 3.6m.

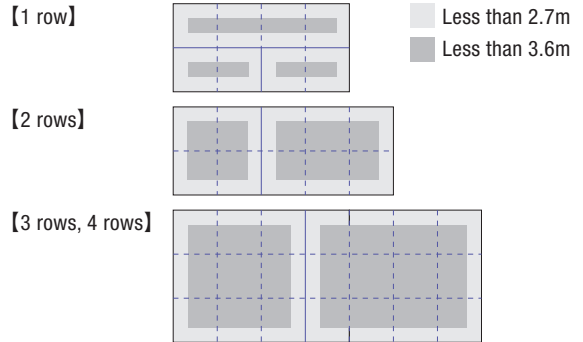

b. More than 20 booth spaces (block booths)

The height limit is 6m.

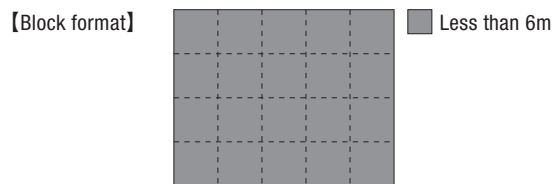

(4) If product sizes exceed height limitations

The height limitation on product exhibits and decorations is stipulated above. If exhibited products exceed these height limitations, the exhibitor should submit Application for Over-Regulated Heights and booth plan drawing to the Show Management Secretariat and the exhibitor must receive prior permission from the Inter BEE Organizing Committee. Product exhibits are to be displayed within the specified space limitations of the exhibition booth and not displayed in a way that would encroach upon corridor spaces. Exhibited products that have received prior permission to exceed height limitations must be exhibited in their original state. No additional decorations are permitted.

2. Small Package Booth

- a. Booth space : 1,980mm(W) x 990mm(D) x 2,700mm(H)
- b. Specification : The following facilities are included in

- Wall panels
 - Display counter (975mm high with storage space)
 - Fascia (300mm width)
 - Company Name Display
 - Fluorescent light
 - Electricity socket (single-phase 100V, up 1 kW output)
- *Small package booth exhibitors may apply for up to two booths.

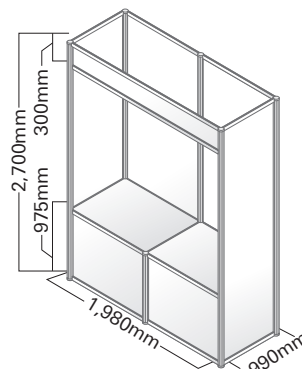

Inter BEE 2012 Exhibition Regulations

3. Booth description

At Inter BEE, booths are available in two types, a standard booth and small package booth. Regardless of type, however, all fees for booths will be referred to as the exhibit booth fee on the invoice statement.

1-5. Number of booths and booth type

	Booth Type	Number applied for
Standard booth	1 row	1. 2. 3. 4. 5. 6
	2 rows	4. 6. 8. 10. 12
	3 rows	9. 12. 15. 18
	4 rows	16
	Block format	20. 25. 30. 35. 40. 45. 50. 55. 60. 65. 70. 75. 80. 85. 90. 95. 100
Small package booth		1. 2

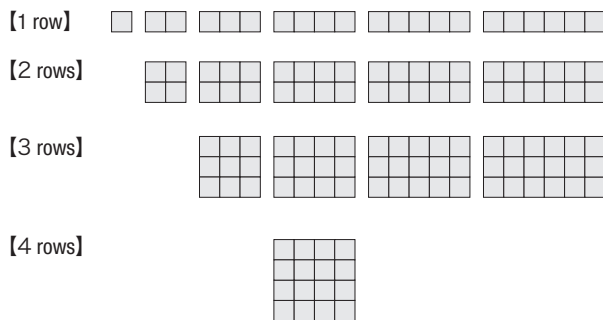

- Exhibitors in rows (less than 18 booths) may have booths of other exhibitors on one or three sides.
- Industry organizations and joint exhibitors may apply for more than 100 booths.
- After the deadline for applications, the Organizing Committee will determine the layout of the show site. If the total space applied for exceeds the capacity of the site, the Organizing Committee reserves the right to determine an impartial method to reduce the number of booths applied for by exhibitors.

1-6. Allocation of booths

Booth locations will be determined by lot drawing. Lots will be drawn among exhibitors who have the same number of booths or share the same configuration in the same categories. However, depending on actual conditions at the booth allocation, lots may be drawn among exhibitors who have approximately the same number of booth spaces (± 10 spaces) in the same stage (i.e. exhibitors with 25 to 35 booth spaces).

In addition, exhibitors in the Professional Lighting category may illuminate towards the ceiling; however, considering the influence on surrounding exhibitors, please note that such exhibitors' booth will be located at the far end of show space. (The drawing of lots is scheduled for July 26.)

1. Primary lot drawing

Exhibitors who have submitted applications by Thursday, May 31, may participate in the primary lot drawing. Please be aware that the number of booths can be changed until the end of June and that the Organizing Committee may adjust the order of the drawing in the event that exhibitors change the number of booths for which they applied to fit their needs after the end of June.

2. Secondary selection

Exhibitors applying from Friday, June 1, through Friday, June 29, may select their booth locations from the locations that remain vacant, in the order of which applications are received.

3. Spare booth spaces

If booth spaces remain available at the end of the lot drawing dates, the remaining spaces will be placed on the floor as spare booths. Exhibitors submitting applications after Saturday, June 30 can select their booth locations from the available spare booths on a first-come, first-served basis.

4. Fixed booth spaces

The Organizing Committee has determined the following booth spaces to be fixed:

- Because lots are drawn among exhibitors with the same number and type of booths in the same exhibit zones, an exhibitor not meeting this criterion will be afforded a fixed booth space(s).
- Cooperative exhibitors
- Overseas cooperative exhibitors and related domestic exhibitors.

5. Utility booths will be setup in spare open spaces after the booth lot drawing is completed. However, exhibitors should be aware that further changes in booth allocation may occur due to exhibitor cancellations, reduction in booth spaces, etc.

6. The position of entry ways and the use of block booths by exhibitors may be adjusted by the Organizing Committee in consideration of overall visitor flow.

7. Overhead lighting

Full overhead lighting delivers approximately 500 lux, but exhibitors in the Video and Broadcast Equipment category may choose to locate their booths in areas where all overhead lighting is decreased (approximately 50 lux). Please note that this option may not be available, depending on the ratio of visitors requesting overhead lighting. For exhibitors in the Professional Audio Equipment category, only the option of full overhead lighting (approximately 500 lux) is available and all overhead light is not available for those in the Professional Lighting category (approximately 50 lux).

Exhibition Categories	Overhead lighting
Professional Audio Equipment Zone	Full overhead lighting (approx. 500 lux)
Professional Lighting Equipment Zone	All overhead lighting off (approx. 50 lux)
Video and Broadcast Equipment Zone	Full overhead lighting (approx. 500 lux) or All overhead lighting off (approx. 50 lux)
Cross-media	Full overhead lighting (approx. 500 lux)

Inter BEE 2012 Exhibition Regulations

2. Booth fees / exhibit applications and contract details

2-1. Booth fees

1. Standard Booth

(1) The exhibition fee per booth space is as follows:

General exhibitors (standard rate)	@¥283,500 (including tax)
<ul style="list-style-type: none"> • JAPAN Electronics Show Association members • IABM Members (member rate) 	@¥252,000 (including tax)

(2) Small package booth (includes basic decorations)

One booth	@¥152,250 (including tax)
Two booths	@¥304,500 (including tax)

2-2. Items included in the booth fee

Invitation leaflets and registration cards for visitors	150 per booth	
Badges	For exhibitors	10 per booth
	For constructors	5 per booth
Electric power supply costs and expenses Single-phase 100V or 200V	1kW per booth	
Electric power usage	Free of charge	
Bar code registration system	System charge	Free of charge
	Bar code terminal rental charge	1 terminal per exhibitor
Home page listing	1 page per company	

2-3. Other fees

1. The following items are not included in the both fees.

*includes consumption tax

Invitation leaflets and registration cards for visitors (in excess of the number of free leaflets and cards indicated above.)	¥30 per set	
Badges	Exhibitors (in excess of 10 badges per booth)	¥1,000 per badge
	Constructors (in excess of 5 badges per booth)	¥500 per badge
Electric power supply costs and expenses	Single-phase 100V or 200V	¥6,825 per kW
	Three-phase 200V	¥6,825 per kW
Bar code registration system Rental charge for bar code terminal	For two or more terminals, ¥8,400 per terminal	
Overtime work	¥10,500 per hour	

2. Booth decorations other than basic panels

Booth decorations other than system panels are to be handled by exhibitors.

The Show Management Secretariat offers package booth programs.

Basic specification of package booth

- Fascia
- Company name display
- Reception counter(s)
- Chair(s)
- Spotlights
- Fluorescent lights
- Carpeting
- Electricity socket(s)

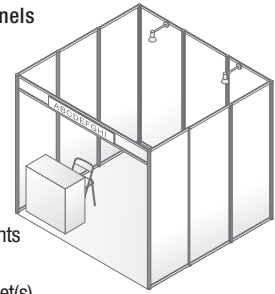

One Package booth	¥73,500 (including tax)
Two Package booths	¥115,500 (including tax)
Three Package booths	¥157,500 (including tax)

*Numerous variations are available. Details will be available in the Exhibitor Manual.

3. Other

Additional expenses may be charged as required by law and regulations. Details regarding these charges will be provided in the Exhibitor Manual.

2-4. Exhibition application and contract agreement

To apply for and contract exhibition space, fill in the information required on the exhibition contract application form, and submit the form to the Show Management Secretariat of the Japan Electronics Show Association (JESA), which will confirm your full understanding of the exhibition regulations. Upon receiving the application form, the Show Management Secretariat will send a receipt confirmation notice via e-mail. The receipt date stated in this confirmation e-mail is regarded as the contract date, whereupon exhibitors are liable for participation fees. If applying in multiple categories, a separate application is required for each category. However, the Organizing Committee reserves the right to advise exhibitors on the most appropriate location for their booths. In addition, exhibitors are required to submit one application per Category if applying for booth spaces in multiple Categories.

1. Applications should be sent to:

Japan Electronics Show Association (JESA)
 12F Ote Center Bldg., 1-1-3 Otemachi, Chiyoda-ku, Tokyo 100-0004
 TEL : 03-6212-5231 FAX:03-6212-5225

2. Application deadlines

(1) **First application deadline: Thursday, May 31st, 2012.**

Applicants may participate in the primary booth allocation lot drawing.

(2) **Second application deadline: Friday, June 29th, 2012.**

Applicants may participate in the secondary selection.

*Even prior to these deadlines, no more applications will be accepted if all booth spaces have been filled.

(3) **After the second deadline**

Applications will be accepted after June 30th, 2012 or until all available booth spaces are taken.

3. Submitting a company profile

First-time exhibitors to the show are required to provide a company profile and catalog(s) of product(s) planned to be exhibited upon submission of the exhibit application / contract. And, if there are major changes made to the corporate profile or catalog(s) of product(s) planned to be exhibited after the company has submitted these documents, an updated profile and / or catalog(s) must again be submitted.

Applications without these documents will be put on hold until the Show Management Secretariat confirms the receipt of these items.

Inter BEE 2012 Exhibition Regulations

3. Submitting a company profile

First-time exhibitors to the show are required to provide a company profile and catalog(s) of product(s) planned to be exhibited upon submission of the exhibit application / contract. And, if there are major changes made to the corporate profile or catalog(s) of product(s) planned to be exhibited after the company has submitted these documents, an updated profile and / or catalog(s) must again be submitted.

Applications without these documents will be put on hold until the Show Management Secretariat confirms the receipt of these items.

4. Cooperative exhibitions or neighboring exhibitions which involve more than two companies

Exhibitors who wish to maximize the effects of exhibitions by holding cooperative exhibitions with group / affiliated companies in one booth or neighboring exhibitions with other companies, must submit applications according to the following criteria.

(1) Collaboration exhibitions

One of the exhibiting companies should submit an application and pay booth fees. Please fill in and submit "Collaboration exhibitor registration form" which is sent to you by the Show Management Secretariat upon completion of application of cooperative exhibitions. By submitting this form, you can print the names of affiliated companies on the lists and the layout.

(2) Neighboring exhibitions

- The total number of booths requested by each company conforms to the standard booth specification and configuration.
- Each company should pay its booth fees separately.
- The position of booths will be decided by the lot drawing among the total number of booths applied for.
- We will confirm if the panels on the sides neighboring booths of other exhibitors and booth numbers are available on the questionnaire.

(3) Cooperative exhibitions

- Total number of booths requested by each company does not conform to the standard booth specification and configuration.
- Exhibitors wish to have booths facing each other on each side of the entryway.
- The number of booths requested by each company conforms to the standard booth specification and configuration.
- Each exhibitor should pay booth fees separately.
- The position of booths will be decided by the Show Management Secretariat beforehand. It is not possible to choose the position of booths.
- We do not allow linking of standard booths and small package booths.
- Please be aware we reserve the right to refuse applications if we cannot verify validity of the cooperative exhibitions. Also, please be aware that we cannot accommodate your requests concerning the configuration of booths.

5. Refusal of application

Applications from any persons involved in bankruptcy, composition, receivership, civil rehabilitation, or corporate reorganization proceedings, or persons who are suspended from current account transactions from financial institutions will not be accepted. Similarly, applications from any persons deemed by the Association to be involved in similar circumstances will not be accepted. If an exhibitor company is found to fall into one of the categories described above after the contract has been concluded, the contract will be voided and that company will not be permitted to exhibit. In such a case, participation fees paid by exhibitors will be refunded. If deemed necessary by the Association, an investigation or inquiry into the surrounding circumstances will be conducted.

2-5. Payment of booth fees

Booth space payments are to be paid via electronic bank transfer according to the schedule below. JESA will issue an invoice and designate the bank account for remittance at this time. Checks and promissory notes are not acceptable as payment. Transfer fees are to be borne by the exhibitor.

Payment deadline

Primary applicant	Tuesday, July 31
Secondary applicant	Friday, August 31

2-6. Cancellation or reducing the number of booths

If an exhibitor cancels or reduces the number of booth spaces applied or, regardless of the reason, some or all of the following cancellation fees will apply. Consumption tax (5%) will be added to all fees.

July 1 to July 31, 2012	60% of exhibition booth fee
August 1 to August 31, 2012	80% of exhibition booth fee
On or after September 1, 2012	100% of exhibition booth fee

Please notify us promptly of cancellations of exhibitions, and additions / reductions of booth spaces. Please fill in and submit "Application for booth cancellation or changes for number of booth(s)" that is sent to you by the Show Management Secretariat. The Show Management Secretariat will inform you that it has received the application as a confirmation.

3. Important exhibit details and prohibitions

3-1. Exhibiting of products from outside of Japan (including fixtures)

Inter BEE plans to make all exhibition halls open to the display of bonded goods. Therefore, it will be possible for exhibitors to display overseas products (those manufactured outside Japan or items that have not yet cleared Customs proceedings) even if they have not cleared Customs by the time the exhibition begins.

3-2. Protection of industrial property rights

Up until last year, exhibiting companies exhibiting items that required an application for patents had to make such an application with the exhibition organizer beforehand at Inter BEE and confirmation work was carried out during the exhibition. However, due to a revision of the Patent Law; from 1st April, 2012, it is no longer necessary for exhibiting companies to make an application regarding patents beforehand to the exhibition organizer, and exhibiting companies must now apply directly to the Patent Office. They can apply for the exception to lack of novelty of invention and special claims may be made when filing an application.

Please access the Patent Office's website for more details regarding the revised law.

Inter BEE 2012 Exhibition Regulations

3-3. Prohibited activities

The following activities are considered as prohibited:

1. **Exhibit space transfer**
Subletting, selling, transferring, or exchanging exhibition space, either in whole or in part, to any third party, including other exhibitors.
2. **Directing visitors to other venues**
Directing Inter BEE visitors to simultaneous product or technology exhibits off-site is prohibited.
3. **Engaging in sales activities**
Selling products other than publications and software on-site during the show is prohibited. Exhibitors who wish to sell publications and software are required to submit details and seek approval in advance.
4. **Inappropriate behavior**
Aggressively attempting to attract visitors to view demonstrations while standing outside of booths or in aisles is prohibited. Persistent sales approaches and/or techniques considered to be excessive are also prohibited.
5. **Exhibiting for the purpose of obtaining personal information**
It is prohibited to use booths for the primary purpose of collecting personal information on visitors, rather than to display products and services. Furthermore, all exhibitors are requested to abide by the stipulations in Japan's personal information protection legislation. Details on the collection and handling of personal information will be available in the Exhibition Manual.

3-4. Responsibilities of exhibitors

1. **Prompt fee payment**
Exhibitors will pay all exhibitor fees and expenses invoiced by Show Management Secretariat and bear responsibility until all payments are complete.
2. **Obeying the law**
The laws and regulations of Japan shall be followed in all cases related to the transfer and management of display and related items, and in management and other matters related to constructs and structures for use in exhibits.
3. **Liability for damage, management of exhibited items, and insurance.**
 - (1) The sponsors, organizing committee and Show Management Secretariat will make every effort to ensure the security of exhibits during the show period by, for example, implementing security guard patrols. However, the management cannot assume responsibility for damages arising from natural disaster, fire, theft, loss of property or other occurrences beyond its control and recommends that exhibitors take steps of their own.
 - (2) Exhibitors shall be liable for any fatalities or injuries occurring to visitors, other exhibitors or third persons as well as damage to items at the exhibition site. Inter BEE sponsors and / or the organizing committee shall bear no responsibility whatsoever in such circumstances.
 - (3) A booth manager, whose responsibility is to supervise all activities that take place in the exhibitor's booth, must be confirmed with the organizer prior to the start of the exhibition.
 - (4) Exhibitors are recommended to provide for adequate insurance coverage during the exhibition.

- (5) The organizer will make every effort to provide effective management, enhanced safety, and maintenance of order at the venue as well as ensure the safety of exhibition visitors. Any act by an exhibitor(s) that is considered detrimental to the aforementioned may lead to the termination of that exhibitor's demonstration. Exhibitors shall be liable for any accidents that may occur during exhibitor demonstrations, and Inter BEE sponsors and / or the organizing committee shall bear no responsibility whatsoever in such circumstances. In the event of an accident, the exhibitor is required to take appropriate action and report it immediately to the organizer.

4. Complying with the exhibition schedule

Prior, during and after the show, all exhibitors are requested to comply with the exhibition schedule specified by the organizer. Construction activities to the booth, delivery and/or wrap-up activities during the exhibition are prohibited.

3-5. Termination or shortening of exhibition duration due to unavoidable or potential calamity

- (1) If the exhibition is canceled because of an event of force majeure, such as an earthquake, typhoon, fire, disease, terrorist act or order from the public authorities, the organizers reserve the right to shorten the duration of the exhibition or the hours that the exhibition is open to the public, either before or during the exhibition. If the exhibition sponsors deem such action necessary, this information will be promptly published on the official Website and exhibitors will be notified. Neither the exhibition organizers nor the Association shall assume any liability for losses incurred by exhibitors in such a case.
- (2) If an unavoidable calamity that occurs prior to the opening of Inter BEE forces cancellation of the exhibition, participation fees paid by exhibitors will be refunded in full, minus charges for expenses already incurred.
- (3) Neither the exhibition organizers nor the sponsors shall be held liable to refund exhibition expenses, either in full or in part, if the exhibition duration is unavoidably shortened because of a calamity or potential calamity.
- (4) The exhibition sponsors and the Show Management Secretariat assume no responsibility for expenses incurred by exhibitors if the exhibition is canceled or shortened because of a calamity.

3-6. News gathering and filming

Staff members appointed by the sponsors and / or the organizer will be authorized to gather news and / or conduct interviews as well engage in filming and / or photography. Exhibitors are requested to cooperate with such news gathering and filming activities and also agree that any image, photograph, information, etc. obtained during the exhibition can be used solely for the purpose of promoting Inter BEE.

3-7. Dealing with disputes between exhibitors

Any disputes between exhibitors concerning exhibits, publicity materials related to exhibits, intellectual property or the use of booths shall be resolved between the parties concerned. The exhibition sponsors shall bear no responsibility whatsoever in such instances.

Inter BEE 2012 Exhibition Regulations

4. Matters related to the booth set-up

4-1. Booth design

Product exhibits, demonstrations, etc., must be conducted within the exhibitor's booth. If for some reason this rule is not followed properly, the organizing committee and / or the Show Management Secretariat will request that the exhibitor comply with the rule; any further noncompliance may result in termination of the exhibitor's booth.

1. Prohibition of usage of space beyond booth boundaries

- (1) Exhibitors are responsible for controlling crowds around their booths, which might block walkways in public spaces. If a stage is set up in a booth, the Exhibitor must ensure that the booth layout makes it possible to bring all visitors inside the boundaries of the booth.
- (2) Inviting visitors into booths and/or conducting surveys in walkways in public spaces is strictly prohibited.
- (3) Exhibits, decorations, fixtures, plants and packaging materials should not be left outside of booths, but must be stored within booths.
- (4) Product exhibitions and presentation acts using the space outside the booth such as the aisle is prohibited.
- (5) Lighting directed toward aisles, exhibition hall walls or ceiling is prohibited.

2. In-booth stages

Exhibitors planning to set up a stage in their booths must ensure that the booth layout makes it possible to bring all visitors inside the boundaries of the booth. Further more, depending on the height of the stage and the video equipment installing, take sufficient care of the visitors viewing angle and of an appropriate distance. If any problems occur in line with in-booth stages, the Show Management Secretariat will request immediate countermeasures.

Good example

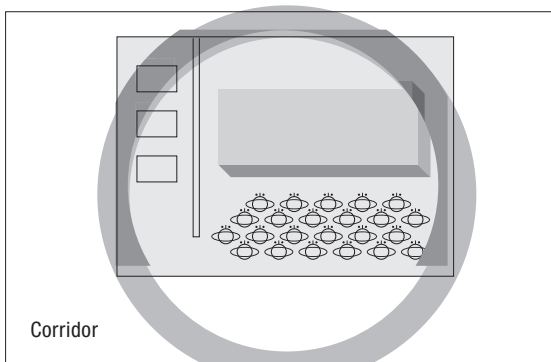

Bad example

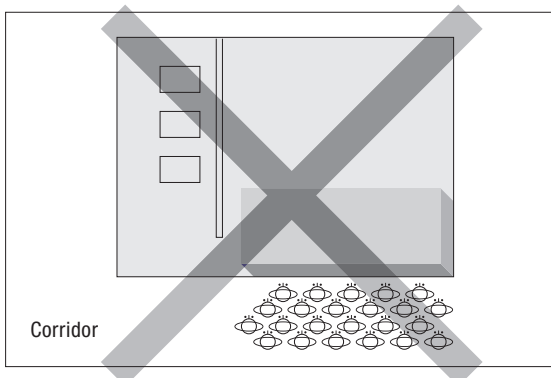

3. Thoughtful independent booth design that allows for an evacuation route
When designing an independent booth, be sure to fully consider the location of adjacent companies' booths, and carry out thoughtful design that allows for an evacuation route and does not obstruct the view of adjacent companies' booths.

4. Speakers

Exhibitors are prohibited from setting up public address systems, such as loudspeakers or mixers, directly facing neighboring booths. So as not to inconvenience visitors or neighboring booths, these systems must be positioned facing the stage. If installing loudspeakers on booth walls or displays fixture pillars, the central axis of each speaker must be 45 degrees or less.

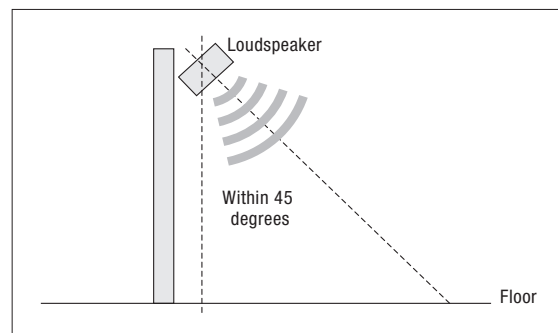
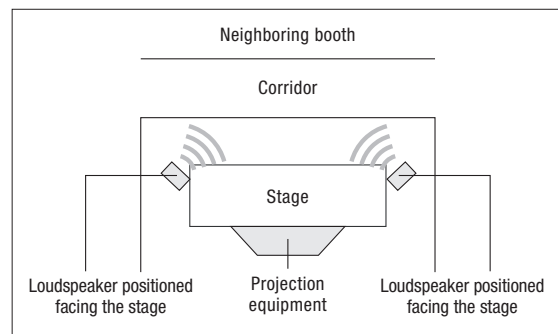

4-2. Ceiling structure and two-floor construction

1. Ceiling structure

Installing a ceiling on the booth is only permitted when products and/or demonstrations need to be shielded from light or insulated from sound. The ceiling must be made of a fireproof blacked-out curtain, which is the only material permitted under local fire department restrictions. Direct sunshine will be blocked out within the exhibit halls but there still may be some reflections cast from the indirect and ceiling lighting. Exhibitors who wish to set up ceiling structures, without regard to the size or area, are required to submit an application form sent with the Exhibition Manual together with top and elevated view booth drawings. Observe the following guidelines for the design and construction of a ceiling structure.

(1) Structure

- ① Any double layer structure is prohibited.
- ② All the decorating materials must be fire-resistant processed and attached the fire-resistant indications.
- ③ Exhibitors are required to submit both top (designated ceiling area and its size) and elevated view (designated ceiling area and surrounding wall, etc.) booth drawings. They must show that the ceiling are fire-resistant processed.

Inter BEE 2012 Exhibition Regulations

(2) Fire Safety Equipment

- ① Fire extinguishers must be size 10 or larger.
- ② Fire alarms (smoke alarms) may be required. In such case, exhibitors must submit the placement notice and its operation experiment result to the Management Office.
Domestic fire alarms are not be accepted.
- ③ Depending on the structure or size, evacuation exits and leading light for emergency may be necessary.

2. Two-floor construction / Suspended Structure

Two-story structures and suspending decorations from the ceiling are not allowed.

4-3. Floor work

Prior to performing flooring work, exhibitors are required to submit to the Show Management Secretariat the actual number of anchor bolts to be used in the floor plan. The use of concrete nails, dry pits, and the mounting of pit lids to anchor bolts is prohibited.

1. Restoring the site to its original condition
Restoration to original condition Floor work is permitted on the condition that all flooring will be restored to its original state after the exhibition. After usage, if the bolt heads project above the surface, they must be sawn off, not hammered in or cut with acetylene torches. All expenses for restoration shall be borne by the exhibitor. In the event that the floor is not restored to its original condition after the final floor inspection, or the restoration is incomplete, the Show Management Secretariat will complete the restoration work and charge the total amount of expenses to the exhibitor after the exhibition.
2. Floor restoration expenses
Exhibitors are required to pay the floor restoration fees regardless of the size of anchor bolts used. ¥1,050 (including consumption tax) per anchor bolt.

4-4. Fire prevention regulations

Inspections by the local fire department will be carried out during the display construction work of after its completion. Any work not in accordance with the below regulations may be suspended, or the structure(s) in question removed. Exhibitors are required to follow the instructions below.

1. Any type of material, whether cloth or paper, affixed to plywood for display purposes should be fireproof.
2. Materials such as display mountings, artificial flowers, draperies, drop curtains, display plywood, fiber blinds, blackout curtains, carpeting or other flammable materials must be fireproof. Please attach a Fireproof tag to each of these materials in an easily visible location.
3. Avoid using paper flowers, urethane, acetate, polyester, nylon or other materials that are difficult to fireproof.
4. The use of plastic foam is prohibited. Please substitute Styrofoam or similar materials.

5. Exhibited items and management

5-1. Counterfeit or imitation products are strictly prohibited

1. The display, distribution, or demonstration of counterfeit or imitation products that infringe on a third party's intellectual property rights (e.g. patents, trademarks, design rights, copyrights, overseas rights, etc.) or any other related activity is strictly prohibited.
2. If the Organizing Committee discovers counterfeit or imitation products being displayed, distributed, or demonstrated, it reserves the right to remove these products from the exhibition venue immediately with all costs incurred becoming the responsibility of the offending exhibitor.
3. In addition to inspections for counterfeit or imitation products, all exhibitors shall cooperate with the Organizing Committee whenever any type of inspection is conducted.
4. Any disputes concerning the intellectual property rights of exhibited products shall be resolved between the parties concerned.

5-2. Comparison displays

As a general rule, exhibitors are requested to limit product comparisons (see guidelines below) to demonstrations between products and / or technologies of their own company or group companies. Exhibitors who plan to compare their products or technologies with those of other companies should first obtain advance permission from the other company and such comparisons must not infringe upon the property rights of that company.

1. Comparisons using exhibits and demonstrations.
2. Comparisons using information panels and pamphlets.
3. Verbal comparisons in audio announcements.
4. Other comparisons related to products and technologies.

5-3. Suitable displays

The following regulations must be strictly observed for all displays in the exhibition booths.

1. Safety and precaution signage
All booths must have adequate safety and precaution signage positioned in clearly visible locations around the displays.
2. Displays should reflect real-life situations
Product presentations and / or displays should be demonstrated in real-life situations as much as possible and not in an exaggerated or unrealistic manner. If this is not practical, the product(s) must have accompanying captions stating how they are used in actual applications.

Inter BEE 2012 Exhibition Regulations

5-4. Vehicle display

When displaying broadcast relay vans or other vehicles, please be certain that the vehicle can be stored within the space stipulated by the booth specifications. If this height is exceeded, please specify that "display exceeds height regulations" and complete the over-height application from.

5-5. Restrictions on Audio Volume

When explaining products or making demonstrations, audio volume in the booth must be maintained at the levels less than 75dB. Please remember that it is important to maintain audio volume at reasonable levels to ensure that visitors can hear the presentations of other exhibitors.

1. The value is the standard, when measured from 2 m away from the border line of booth. These levels must be observed throughout every booth.
2. During the exhibition period, the Show Management Secretariat will regularly measure sound levels. Exhibitors are also asked to voluntarily measure sound levels within their booths before and during the exhibition. Contact the on-site Management Office to borrow measuring equipment.
3. Breach of noise-level restrictions: Any exhibit exceeding the specified noise levels must be modified to conform to regulations. Failure to conform may result in the loss of exhibiting privileges.
4. Regardless of these regulations, if complaints are received from neighboring exhibitors or noise is noticeable in other areas of the site, the Show Management Secretariat will require the exhibitor in question.
5. Please make sure that a person responsible for audio equipment is stationed in your booth at all times, and that the audio equipment is operated in accordance with the regulations.

5-6. Demonstration regulations

1. Copyrights

Exhibitors playing music or replaying recorded audio or video material must pay royalties on said material (unless the exhibitor owns the rights or has made separate arrangements for payment of royalties). Royalties are payable to the Japanese Society for the Rights of Authors, Composers and Publishers (JASRAC), which handles royalties in Japan.

Please contact JASRAC for details on arrangements and royalty calculation methods. In addition, when exercising rights regarding video and animation, please contact the company or organization/group that owns the copyright.

2. Illumination / Lighting

No illumination that projects directly into another company's lighting or onto walls or corridors is permitted. Exhibitors in the Professional Lighting category who need to illuminate in distance to describe or feature its exhibit product may illuminate only towards the ceiling within the exhibitor's booth.

When strong lighting equipment such as LEDs are used in displays and / or signboards, they must be positioned so as not to inconvenience visitors or neighboring booths.

3. Smoke machines

The use of smoke machines (including alcohol, oil or petroleum smoke machines, and dry ice machines) is not permitted.

4. Other

Please take preventive measures to avoid the generation of the following during demonstrations. Please be considerate of other exhibitors and visitors.

1. Hot air
2. Gases
3. Odors
4. Vibration

5-7. Handling of hazardous items

1. The Fire Prevention Law Prohibits the Following Activities on the Exhibition Site

- (1) Smoking
- (2) Live flames (spark-producing items, exposed elements, etc.)
- (3) Liquefied petroleum gas (LPG) or other flammable / pressurized gases
- (4) Hazardous objects (gasoline, kerosene, other oils, etc.)
- (5) Hazardous materials
(explosives, matches or disposable lighters in large quantities, etc.)

2. Exemptions for prohibited activities

Excluding smoking, exemptions for prohibited activities and / or the use of some of the aforementioned substances may be granted by local fire safety authorities if it is determined that only minimal amounts of substances will be used or that the activities are necessary to enhance the exhibit. For exhibitors seeking exemptions, please fill in the relevant items on the "Hazardous Materials Usage Application" in the exhibitor's manual and submit the form together with two declaration copies explaining the nature of the performance or exhibit. The association will submit all applications to the fire safety authorities at a single time, and only the items granted exemptions will be allowed to be used in the venue.

3. Smoking

Smoking is prohibited in booths. Smoking is permitted only in specially designated smoking areas.

4. Live Flames

The following should be strictly observed when using live flames:

- (1) Minimize the size and quantity of on-site equipment to the extent possible and use devices of the same type.
- (2) Protect the surrounding area with fireproof materials.
- (3) Monitor conditions closely and provide adequate fire safety equipment.
- (4) At least one fire extinguisher must be available (with a 2-unit minimum fire extinguishing capability and a minimum size of 10).
- (5) A designated person responsible for fire prevention and extinguishing any possible fire must be stationed in the booth.
- (6) Live flames must be at least 5 m from fire exits, hazardous materials and other flammable materials

5. Liquefied Petroleum Gas (LPG) or Pressurized Gas

The following rules should be strictly observed when using LPG and other pressurized gases (oxygen, hydrogen, nitrogen, carbon dioxide, argon gas, etc.):

- (1) After installation, test all containers for leaks, and if necessary display a "Caution: Do Not Use Near Flammables" sign on them.
- (2) Use pressurized gases under the lowest possible pressure, and handle containers carefully. Bringing flammable gas cylinders (except cartridge types) onto the exhibition site is prohibited.
- (3) To prevent gas leakage, use a complete connector for all connecting parts and monitor continuously with a gas leak detector.

6. Hazardous Materials

When using hazardous substances in the exhibition venue, the following regulations must be strictly observed.

- (1) Bring only one day's supply or less onto the exhibition site.
- (2) Do not replenish supplies during exhibition operating hours.
- (3) Provide adequate fire safety measures and handle materials carefully at all times.
- (4) Place hazardous materials 6 m and other materials 3 m or more from fire escapes.
- (5) A Type 10 fire extinguisher must be readily available.
- (6) Place hazardous materials 5 m away from areas in which open flames are being used.
- (7) Appoint personnel to monitor safety.

Inter BEE 2012 Exhibition Regulations

6. Violation of the regulations and discrepancies in interpretation / Others / Organizing Committee

6-1. Violation of the regulations and discrepancies in interpretation

Concerning official regulations, if an exhibitor violates regulations or if there is a discrepancy in interpretation or the application of these regulations, the following measures will be taken. Please note that the interpretation of the regulations as defined in the original Japanese language documentation will take precedence.

1. If the Organizing Committee determines that an exhibitor has violated regulations governing exhibitor booths and implementation of exhibits, the association will request that the exhibitor take the necessary corrective measures.
2. If the same violation described in section 1 above occurs again, or a discrepancy in interpretation of these regulations occurs, the Organizing Committee will take the appropriate action and as a final ruling order, order the exhibitor in question to take the necessary corrective measures.
Please note that once the committee reaches a final ruling, the committee will not enter into any further discussion with the exhibitor in question, nor be responsible for any incurred liabilities whatsoever.
3. If an exhibitor has been ordered to take corrective measures described in section 2 above, the exhibitor will be required to submit in writing on the same day, a description of the necessary corrective measures taken and the schedule at which they will be completed.
4. If an exhibitor has been ordered to take corrective measures described in section 2 above, and fails to do so accordingly, or if the corrective measures taken are determined to be insufficient by the Organizing Committee, the following penalties may apply.
 - (1) The exhibitor will be prohibited from continuing with exhibition activities from the next day.
 - (2) If the penalty in section 1 above is not abided to, the exhibitor will be barred from exhibiting at the subsequent Inter BEE exhibition.

6-2. Others

1. Other prohibited activities and regulations that are not included in these regulations will be detailed in the Exhibitor Manual that will be distributed at a later date.
2. Promissory notes cannot be accepted for payment for booth fee and all the expenses. Transfer fees are to be borne by the exhibitor.
3. These regulations are subject to change as deemed necessary by the show sponsors, the Organizing Committee or the association. If changes occur to the regulations, they will be posted on the Inter BEE Official Website, or brought to the attention of exhibitors by other means.

4. Observing these regulations is the sole responsibility of the exhibitor. The show sponsors, Organizing Committee and the association will not accept any responsibility resulting from violations of existing laws and / or local ordinances by exhibitors.

6-3. Organizing Committee

The Organizing Committee functions as a body to deliberate and decide matters related to the management of the exhibition, including regulations and plans. The Organizing Committee will be represented at the exhibition site during the preparation and execution phases of the exhibition. These representatives will be responsible for maintaining the exhibition environment, dealing with problems and ensuring that the exhibition regulations are adhered to at all times. They have the authority to address problems as they arise.

Basic Policy and Organizational Framework concerning Disaster Prevention and Safety Measures

1. Basic Policy

The Management Office will respond to disasters in accordance with its basic principle of "prioritizing the safety of visitors and exhibitors".

In the event of a disaster, the Management Office will assemble a local disaster prevention organization to gather and provide information, give evacuation instructions, and conduct initial fire-fighting and rescue activities. The Management Office will also cooperate with Makuhari Messe to circulate information between concerned organizations, and strive to ensure the safety of all parties concerned.

2. Organizational Framework

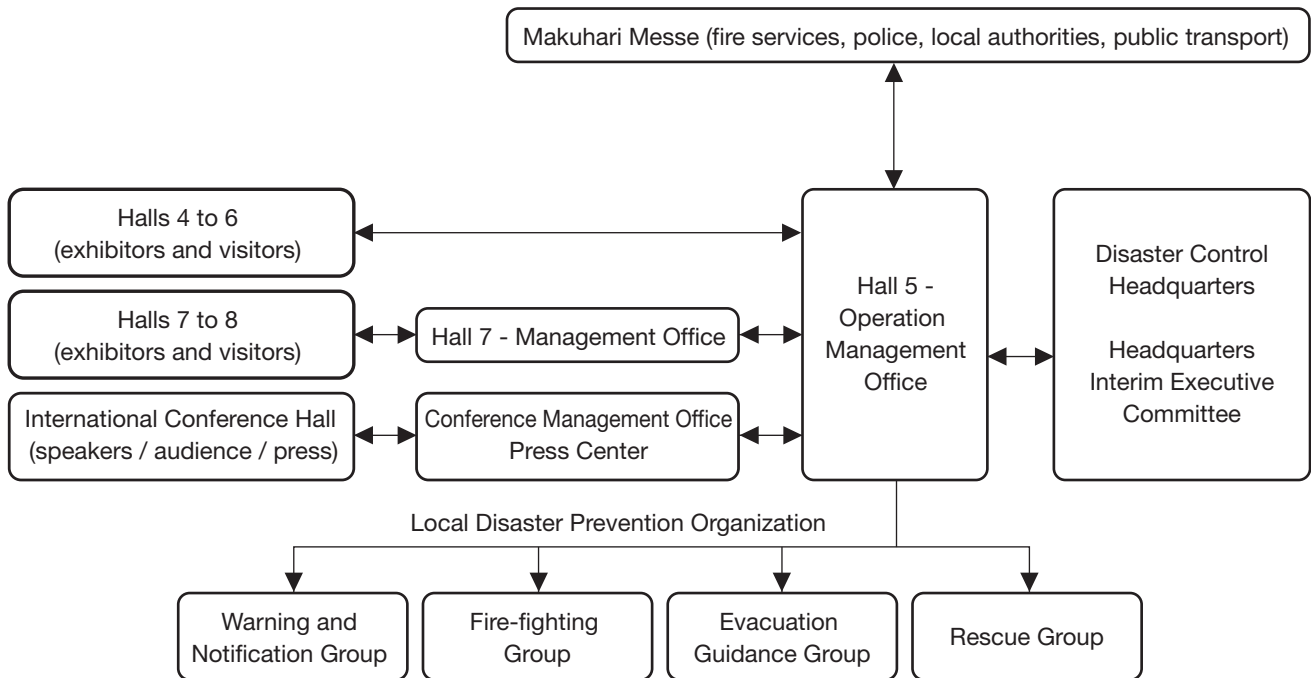

Requests to Exhibitors Concerning Disaster Prevention and Safety Measures

In order to operate a safe exhibition Inter BEE has formulated a "Disaster Prevention and Safety Measures Manual", so we hope that exhibitors can cooperate with the following requests.

1. Advance Preparations

We recommend that all exhibitors refer to the below items and formulate their own safety and disaster prevention manual.

The Management Office has separately issued a "Disaster Prevention and Safety Measures Guidelines" for exhibitors formulating manuals, so please make use of these reference materials.

<p>(1) Registering with the Management Office</p> <p>*All exhibitors must submit</p>	<ul style="list-style-type: none"> ① Contacting the booth manager So that the Management Office can contact you in the event of an emergency, register the mobile phone number and e-mail address of the person in charge of the booth with the Management Office by Friday, October 26 via the "Registration of Booth Manager and Booth Staff". Information that you register with us will be managed in accordance with personal information protection policy when holding this event and will be deleted after the conclusion of the exhibition. ② Number of booth staff Please register the estimated maximum number of staff (company employees, external staff, part-time workers, etc.) occupying and working at the booth for each day to the Management Office by Friday, October 26 via the "Registration of Booth Manager and Booth Staff". The Management Office will provide this information to public organizations such as the police or fire-fighting services in the event of a disaster.
<p>(2) Booth disaster prevention and safety measures</p>	<ul style="list-style-type: none"> ① Formulate a disaster prevention and safety manual to be used in the management of the booth ② Establish an emergency contact network and select contact managers (own company, partner companies, Management Office) ③ Divide roles among staff members <ul style="list-style-type: none"> • Ensure visitor safety and give evacuation instructions • Ensure the safety and confirm the whereabouts of booth staff • Support rescue activities • Maintain the booth (stop demonstrations, stop transmission of electrical energy, look after exhibit products, etc.) ④ Prepare disaster equipment <ul style="list-style-type: none"> • Basic emergency set • Flashlight, etc. ⑤ Check the the site <ul style="list-style-type: none"> • Confirm suspected danger spots in the booth • Confirm the closest primary evacuation place (open spaces such as wide aisles and resting place) • Confirm the closest evacuation exit and route • Confirm the location of fire-extinguishers • Participate in the emergency drill* <p>*9.00-9.15 a.m. 14th November (Wed.) (for more details refer to section 01-2-5)</p>

Requests to Exhibitors Concerning Disaster Prevention and Safety Measures

2. Safety Precautions when Setting Up Booths

After taking into consideration possible disaster scenarios, exhibitors are requested to take the following safety measures when designing and setting up their booth.

<p>(1) Electrical work</p>	<ul style="list-style-type: none"> ① Booth staff will circulate information on the location of temporary distribution boards and select a person to be responsible for turning off the breaker in the event of an emergency. The temporary distribution board to be installed by the Management Office (primary mains work) will act as an earth leakage breaker that automatically cuts off the electrical supply when an earth leakage is detected. ② Do not conceal the temporary distribution board. Also, be sure not to place any packages etc. in front of the temporary distribution board. ③ When installing large-scale lighting equipment such as PAR lighting fixtures, be sure to take measures to prevent them falling such as securing them with wire. <p style="text-align: right;">*For more details please refer to section 04-2-5</p> <div data-bbox="1029 772 1428 996" style="border: 1px solid black; padding: 5px;"> </div>
<p>(2) Designing and setting up booths</p>	<ul style="list-style-type: none"> ① When designing block booth be sure to keep 1/3 (one-third) of the side adjacent to the aisle open to allow for an evacuation route. ② To prevent truss beams falling, strike four or more anchor bolts in one place when securing them to the floor. ③ When installing exhibition panels (OCTANORM), take measures to prevent them falling by reinforcing the panels, reinforcing the beams in the corner sections, and installing weights. ④ Take measures to prevent independent fixtures falling by securing them to the wall or floor surface. ⑤ When installing video monitors, speakers, channel characters, lighting fixtures, and other fixtures located in high places; take measures to prevent them falling by securing them with bolts or wires. <p style="text-align: right;">*For more details please refer to section 04-1-3</p> <div data-bbox="1061 1254 1428 1646" style="border: 1px solid black; padding: 5px;"> </div>
<p>(3) Safety while working</p>	<ul style="list-style-type: none"> ① People working in high places must wear a helmet and a safety belt. ② When using a stepladder for work, be sure to secure it with an anti-opening bracket. ③ When using a rolling tower, be sure to install a handrail and outrigger with a height of at least 900mm around the work floor.

Exhibitors' Response to an Emergency

Please be prepared to act in the event of an emergency by informing all booth staff about how to respond to a disaster.

Earthquake	During	<ul style="list-style-type: none"> •Prioritize your own safety •Secure the safety of booth visitors and booth staff (guide people to the primary shelter)
	Straight after	<ul style="list-style-type: none"> •Give booth visitors evacuation instructions in accordance with officials' instructions when evacuation orders appear outside the evacuation hall over the P.A. system •Continue to evacuate all booth staff •Persons in charge of the booth will maintain the booth (stop transmission of electrical energy, look after exhibit products, etc.)
	After	<ul style="list-style-type: none"> •Support rescue activities as necessary •Confirm the safety of booth staff and identify the status of damage •Make a report to the Management Office
Fire	When discovered	<ul style="list-style-type: none"> •Ensure people's safety (instruct visitors and exhibitors in the near vicinity to evacuate) •Notify the Management Office
	During	<ul style="list-style-type: none"> •Conduct initial fire-fighting activities with a fire extinguisher (prior to the Management Office dealing with the problem)
Suspicious objects	When discovered	<ul style="list-style-type: none"> •Notify the Management Office
Incidents	During	<ul style="list-style-type: none"> •Ensure people's safety (instruct visitors and exhibitors in the near vicinity to evacuate) •Notify the Management Office
	After	<ul style="list-style-type: none"> •The victim files a damage report •Police investigate and deal with the problem
Emergency	During	<ul style="list-style-type: none"> •Check the well-being of people being rescued •If moderate: Lead people to the first-aid center or the closest Management Office location •If serious: Call for an ambulance (if requested by the person concerned or the person accompanying the injured person)
		<div style="border: 1px solid black; padding: 5px; margin-bottom: 10px;"> <p>▶ Primary action: _____</p> <ul style="list-style-type: none"> Contact the Management Office → call an ambulance from the Management Office's office → the Management Office will guide the ambulance into the grounds </div> <div style="border: 1px solid black; padding: 5px;"> <p>▶ Urgent situations: _____</p> <ul style="list-style-type: none"> Directly request an ambulance by calling direct from your mobile phone → notify the Management Office → the Management Office will guide the ambulance into the grounds </div> <p>*Prioritize the well-being and wishes of the people being rescued</p>

Disaster Evacuation Route

1. Evacuation orders

If necessary, the Management Office will give instructions via the P.A. system to evacuate people to the outside the exhibition hall.

2. Example of emergency broadcast message

(1) In the event of a fire:

"This message is for everyone in the venue. There is currently a fire in the vicinity of ○○. The disaster prevention organization has started to deal with the fire, so please calmly follow the instructions of officials and evacuate to the outside of the exhibition hall via the emergency exit."

(2) In the event of an earthquake

① Straight after

"This message is for everyone in the venue. An earthquake has just occurred. Ensure your own safety such as watching for falling objects, and please wait a while in a safe location within the venue. The Makuhari Messe building is supported by a safe structure. We will let you know as soon as we have more details."

② Evacuation order

"This message is for everyone in the venue. An earthquake centered in ○○ measuring at ○○ on the Japanese scale has just occurred. Although the Makuhari Messe building is supported by a secure structure, booths and exhibits may collapse due to aftershocks, so please calmly follow the instructions of officials and evacuate to the outside of the exhibition hall via the emergency exit."

③ In the event of a tsunami warning

"This message is for everyone in the venue. An earthquake centered in ○○ measuring at ○○ on the Japanese scale has just occurred. A tsunami warning has been announced at Tokyo Bay, so please calmly follow the instructions of officials and evacuate to the second floor of the exhibition hall via the emergency exit." The second floor is 11 meters above sea level."

(3) Incidents (bomb warning, etc.):

- ① Calling for attention: "Sakura sakura" (music) played 5 times in succession.
- ② Warning lifted: "Tooryanse" (music) played 5 times in succession

3. Evacuation guidance

Please act calmly and follow the instructions of the Evacuation Guidance Group.

Disaster Evacuation Route

4. Evacuation route

(1) When evacuating to the outside of the Exhibition Hall

When evacuating to the outside of the Exhibition Hall in event of an earthquake or fire, etc., please go to the outside of the exhibition hall shutters.

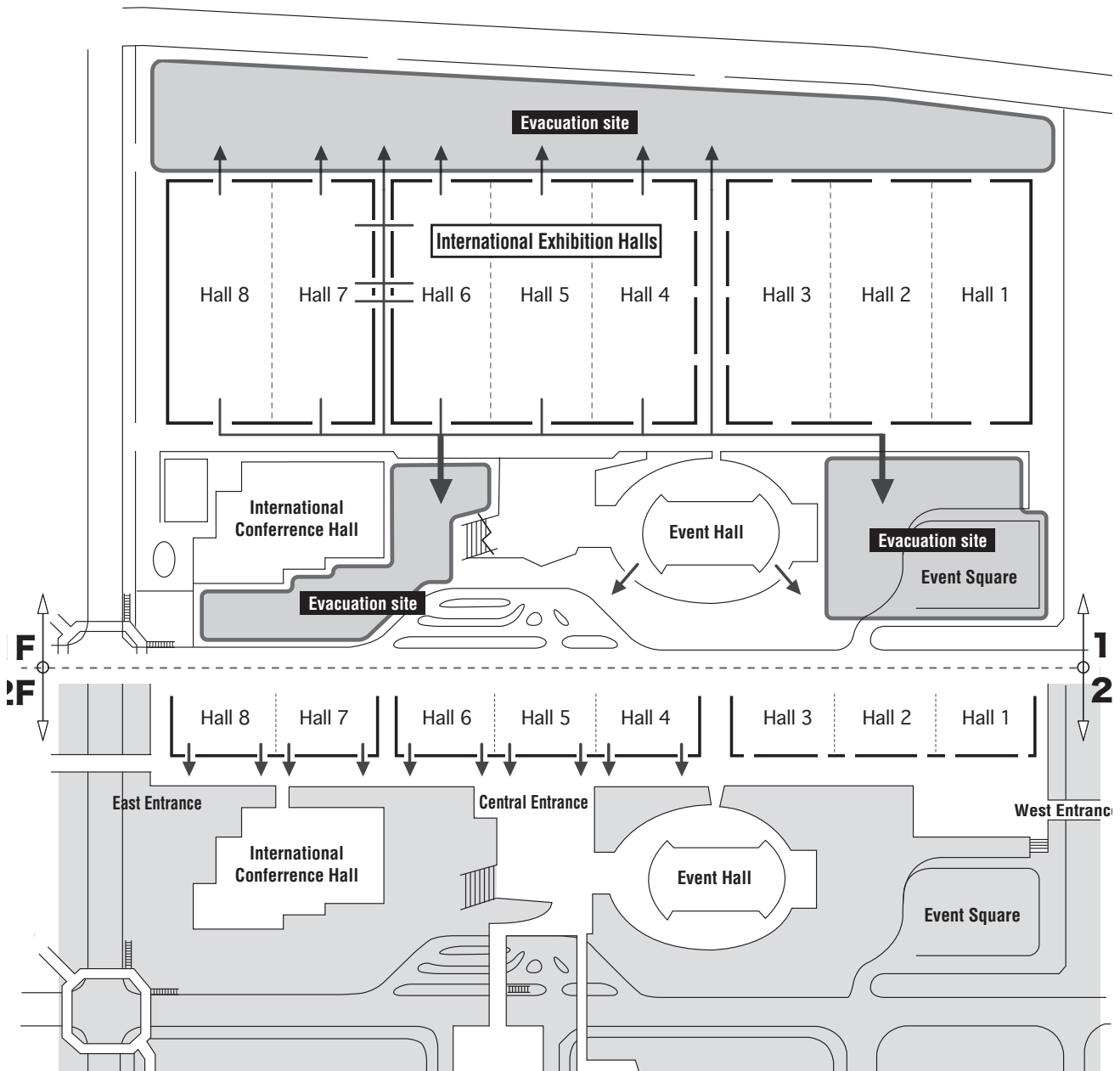

Disaster Evacuation Route

(2) When evacuating after a tsunami warning

When a tsunami warning is announced, evacuate to the second floor aisles of Makuhari Messe or to Messe Mall.

* 1st floor of Makuhari Messe exhibition hall - 8m above sea level; 2nd floor of the exhibition hall - 12m above sea level

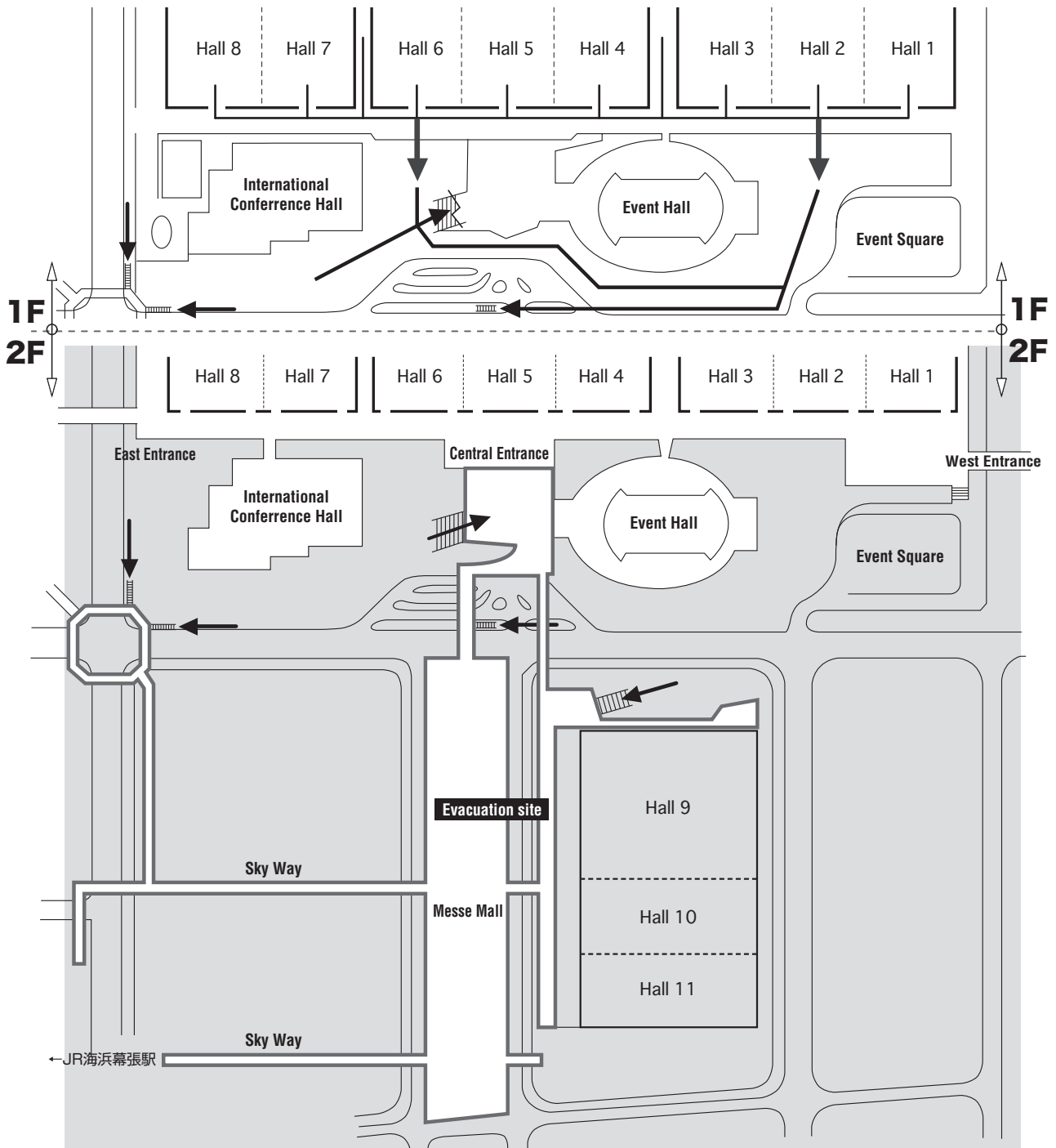

Emergency Drill

We will carry out the below described exhibitor emergency drill to ensure that safety is secured and evacuation instructions are provided swiftly in the event of a disaster.

While we understand that this will be held during a busy time of the day for all exhibitors, we hope that all booths will cooperate when the P.A. system announces the drill. (Voluntary)

Date: November 14 (Wed.) 9.00-9.15 a.m.

	Organizer	Local Disaster Prevention Organization	Exhibitors
9:00 a.m.	Scenario: Occurrence of a strong inland earthquake		
9:01 a.m.	P.A. system announcement (Status report and request to ensure safety)	Evacuation Guidance Group's allocation of emergency exits	Simulation of evacuation instructions (voluntary)
9:03 a.m.	P.A. system announcement (mock earthquake and evacuation orders)	Open emergency exits and start guiding people to the evacuation point	Confirm emergency exits and inform all staff
9:05 a.m.	Confirm and notify the damage(request fire-fighting and emergency services)	Ensure safety and confirm the status of damage Confirm a fire	Confirm the safety of booth staff and the booth
9:10 a.m.	Confirm venue safety	Confirm people requesting help	Summarize information for managers
9:15 a.m.	P.A. system announcement (Order to disband)		

Requests to Help Save Energy

1. Energy saving activities

However, considering that energy-saving activities are impacting companies and households through the government's announced "Summertime Energy-Saving Measures" (electrical power supply and demand review meeting), CEATEC JAPAN 2012 is voluntarily conducting the following activities to save energy. While this may cause exhibitors some inconvenience, we hope to rely on your understanding and cooperation.

2. Energy saving measures by the Management Office

- (1) Reduced air conditioning services
 - (2) Cutting ceiling lights at second floor common areas and restaurants
 - (3) Reduced escalator services
-

3. Exhibitors' energy-saving measures

- (1) Use of components with low consumed power (LED lights, etc.)
 - (2) Energy saving considerations when designing booths
-

4. Cool Biz energy-saving campaign

Promote Cool Biz throughout the event

Personal Information Protection Law

1. Handling of Personal Information

The Japan Electronics Show Association (“the Association”) is entrusted with organizing the exhibition by the Inter BEE organizer. Personal information relevant to this exhibition is appropriately handled in accordance with the Personal Information Protection Policy of the Association.

The Association, which mainly comprises electronic device and electronic component manufacturers, holds exhibitions, seminars, and other activities for the progress of the electronics and information technology industries in cooperation with sponsors. In these activities, the Association fully understands the importance of properly handling personal information and the responsibility for protecting the information.

Therefore, the Association strictly handles information that could be used to identify individuals (“Personal Information”) obtained through its activities, in compliance with laws and other regulations concerning Personal Information.

The Association defines Personal Information as information that identifies individuals, including pieces of information that do not identify individuals directly, but could easily be matched with other information to identify individuals. The Association collects the following Personal Information through documents, electronic media, or websites.

- (1) Name, address, telephone number, fax number, e-mail address, place of employment, affiliation or position
- (2) Bank account or credit card details required for direct-debits or payments for charges related to events

2. Purpose of Using Personal Information

The Personal Information obtained from users at events that the Association operates or is entrusted to operate, will be used for the following purposes under the terms and conditions:

- (1) For sending reports or outlines, etc. regarding the Association’s operations
- (2) For handling invitations such as an exhibitions, seminars, lectures, and other events which the Association is entrusted with, and managing these events (*)
- (3) For administering the Association’s website
- (4) For providing and distributing the Association’s documents such as journals, reports, and proposals
- (5) For handling consultations and messages received from users regarding the activities which the Association operates or is entrusted to operate
- (6) For sending notification, questionnaires, etc. regarding the activities which the Association operates or is entrusted to operate
- (7) For sending proposals and communications regarding the activities which the Association operates, etc.

*The Association gathers personal information in order to improve its services regarding the operation, registering visitors prior to and during exhibitions, and accepting reservations to attend exhibitions, conferences and other special programs.

The Association also collects personal information for use in user questionnaires and for responding to requests for reference materials. Information-gathering activities are also used to provide registered visitors to exhibitions with information on promotions, and the products and services of companies related to the Association. The Association uses personal information only for these purposes.

Personal Information Protection Law

3. Providing Personal Information to Third Parties

No personal information collected by the Association will be provided to unrelated third parties except the cases listed below. However, visitors to exhibitions organized by the Association are issued with personalized barcodes. These barcodes are read upon entering the exhibition and Conference programs, and at the booths of exhibiting companies and organizations (exhibitors). As a result, information that might be considered personal in nature is shared between the Association and the exhibitors. Visitors are requested to understand that exhibitors might send information directly to them by e-mail or post after the exhibition. In addition, user data from the website and exhibition sites are sometimes provided to third parties in a format that prevents identification of individuals. Such information is not considered personal in nature.

- (1) In cases where the consent of the individual is obtained in advance
- (2) In cases where there is a legal obligation to provide Personal Information
- (3) In cases where it is difficult to contact individuals when necessary for protecting their property or personal safety
- (4) In cases where it is difficult to contact individuals when it is especially necessary for improving public health or promoting children's health and welfare
- (5) In cases where it is difficult to carry out the activities by informing the individuals when it is necessary to cooperate with a national organization, local authority, or its consigners in accordance with laws

The Association will restrict the purposes of using Personal Information and take necessary actions according to the above-mentioned cases when it is required to provide Personal Information to third parties

4. Website Operated by the Association

On exhibition websites operated by the Association, cookies are used to provide services customized to individual users and to count the total number of accesses by all users to the site. Individual IP addresses are also collected to collate data on usage of the website and monitor trends in site usage, but these addresses are not used in any way that might lead to the identification of individual users. However, the Association shall be exempt from this stipulation if its legal rights are infringed upon or interfered with by a user(s), or the potential of such infringement or interference is suspected.

5. Managing Personal Information

The Association will protect the security of Personal Information provided by users by strictly managing Personal Information within the scope of the above purposes and by taking extensive measures to protect Personal Information from inappropriate access, loss, destruction, tampering and disclosure.

Regarding activities that the Association is entrusted to operate, the Association will comply with the organizing committee's personal information policies.

When entrusting the handling of Personal Information, the Association will conclude nondisclosure agreements with the contractors and supervise them.

Personal Information Protection Law

6. Disclosure, Modification, and Ceasing Use of Personal Information

When a user requests disclosure, modification, or cessation of use of their Personal Information, the Association will take appropriate action immediately based on the situation.
Users can confirm registered details for e-mail transmission on websites managed by the Association and alter these details.

7. Personal Information Managing System

The Association will establish a strict system for protecting Personal Information supervised by the administration manager, and carefully manage Personal Information.

8. Questions

If there are any questions regarding the protection of Personal Information, please contact us at:

**Japan Electronics Show Association (JESA)
Administration Section**

12F Ote Center Bldg., 1-1-3 Otemachi,
Chiyoda-ku, Tokyo 100-0004, Japan

Tel: +81-3-6212-5231 Fax: +81-3-6212-5225

E-mail: jesa.info@jesa.or.jp

Use of Personal Information by Exhibitors

■ Use of Personal Information by Exhibitors

With respect to the handling of visitors' personal information, the Association shall adopt the aforementioned measures in order to fulfill the requirements of the Personal Information Protection Law. All exhibitors are also required to fulfill the requirements of the Law. The Association therefore requests that exhibitors strictly observe and implement the following items with regard to the handling of personal information obtained at Inter BEE

- ◆ Methods shall be devised for confirming the wishes of the provider (individual) regarding the use of business cards, names written on name lists, information written on survey forms, details written on business cards or personal information obtained using the barcode system.
- ◆ Business cards, names written on name lists, information written on survey forms, details written on business cards or personal information obtained using the barcode system must not be resold.
- ◆ Business cards, names written on name lists, information written on survey forms, details written on business cards or personal information obtained using the barcode system must be used only by the departments and divisions of one's company and must not be passed on to other departments or divisions.
- ◆ In cases where the provider of collected personal information requests not to be contacted, or the information is not to be provided to others, and also in cases where the individual has made it clear that he / she wants the information deleted or erased, use of that personal data is to be stopped immediately, and appropriate measures taken. Also, in cases where the provider of personal information requests disclosure of details held, steps must be taken to provide a response as soon as possible.
- ◆ Appropriate measures must be devised under the guidance of the person in charge of the management of personal information to prevent the leaking of personal information contained on business cards, names written on name lists, information written on survey forms, details written on business cards or personal information obtained by using the barcode system.
- ◆ Exhibitors shall be responsible for the management of business cards, names written on name lists, information written on survey forms, details written on business cards or personal information obtained using the barcode system.

Other appropriate measures shall be taken in accordance with the Personal Information Protection Law.

■ Handling of Personal Information Collected at Booth

When collecting personal information from visitors at booths (apart from data supplied through the barcode system), we recommend that you inform them about the intended use of such information and obtain their prior consent. Samples of items visitors are to be advised of at reception desks are provided on the next page. Please use these as a guide for written notices based on your company's policy regarding the protection of personal information.

Use of Personal Information by Exhibitors

■ Examples of written notices on the handling of personal information by Company X

■ Purposes of Using Personal Information

■ Handling of Personal Information

■ For further enquiries on this matter, please contact the following office.

Receiving business cards

Please provide us with one business card.

Surveys

We ask for your cooperation in taking part in this survey.

Use of barcode system

We will ask permission to scan your barcode.

Our company will use personal information collected for the following purposes, and it will be managed and handled according to stringent protocols.

- ◆ To allow our sales representative to contact you concerning our products on display.
- ◆ To inform you about our products, services, seminars and events.
- ◆ To invite you to the next Inter BEE exhibition and provide other information.

- ◆ We shall not provide personal information to a third party without your consent.
- ◆ We shall manage personal information strictly in accordance with our protocols for its safe management so that such information is not lost, destroyed, falsified or improperly disclosed.
- ◆ We perform appropriate data maintenance to ensure the accuracy of personal information that we obtain. If requested by the person in question to disclose, amend, cease using or delete his or her information, we shall endeavor to do so in an appropriate manner and without delay.

X, Inc., ABC Division
 Contact: Bill Smith
 Tel: 123-4567-8910
 E-mail: aaaa@zzzz.com

Payment of Charges

Page	Service details	How to pay	When to pay
2-3-2	VIP Room	Japan Electronics Show Association	Early December after the closing of Inter BEE 2012
2-4-1	Invitation Leaflet	Japan Electronics Show Association	
2-4-2	Visitor Barcode Service	Neonet Inc.	
2-5-1	Customer's Room	Japan Electronics Show Association	
2-5-2	Presentation Room	Japan Electronics Show Association	
2-5-3	Meeting Room	Japan Electronics Show Association	
2-5-4	Suite Room	Japan Electronics Show Association	
2-6-1	Web Site Banner Advertisement	Japan Electronics Show Association	
2-6-2	E-mail Magazine Text Banner Ads	Japan Electronics Show Association	
2-6-3	Guide Map Advertisement	Japan Electronics Show Association	
2-6-4	On-site Signboard Ads	Japan Electronics Show Association	
3-2-1	Overtime Work	Japan Electronics Show Association	
3-2-2	Additional Exhibitor / Worker Budes	Japan Electronics Show Association	
4-2-3	Floor Work	Murayama Inc.	
4-2-5	Power Supply	Japan Electronics Show Association	
4-2-5	Electrical Power Work Installation Diagram	Japan Electronics Show Association	
4-2-5	Optional Power Transmission	Japan Electronics Show Association	
4-2-6	Green Power Certification System	Japan Natural Energy Company Limited	A / N (As needed)
4-3-1	Foreign-Made Product Exhibition Plan	Ishikawa-Gumi Ltd.	Early December after the closing of Inter BEE 2012
4-5-2	Exhibitors' Utility Booths (Storage)	Japan Electronics Show Association	
5-1-1	Transport within Japan	Ishikawa-Gumi Ltd.	
5-1-1	Load-in / Load-out Services	Ishikawa-Gumi Ltd.	
5-2-1	Booth Display & Rental Fixtures	Murayama Inc.	
5-2-2	PC Rental	Kissei Comtec Co., Ltd.	
5-3-1	Internet Connection	Makuhari Messe Inc.	
5-3-2	Telephone Line	Murayama Inc.	
5-3-3	Antenna Installation	Tofuna Eizo Inc.	
5-2-3	Catering Service for Booths	Nilax Inc.	
5-4-1	Hotel Reservations	Nippon Travel Agency Co., Ltd.	A / N (As needed)
5-4-2	Food / Beverage Tickets	Makuhari Messe Inc	
5-4-3	Lunch Box Delivery Service	Wako Sangyo Co., Ltd.	
5-4-4	Part-time Staff / Interpreter	Ken & Staff Co., Ltd.	Early December after the closing of Inter BEE 2012
5-4-5	Booth Photography	Kurano Photo Office	
5-4-6	Booth Cleaning	Chibaken Bldg-Maintenance Corp.	

Inquiries List

Management Office	Address / Tel. / Fax/ E-mail	Contact	Related document
Japan Electronics Show Association (JESA)	12F Ote Center Bldg., 1-1-3 Otemachi, Chiyoda-ku, Tokyo 100-0004, Japan Tel: +81-3-6212-5231 Fax: +81-3-6212-5225 E-mail: exhibitor@inter-bee.com	Ishizaki Yoshinaga Ohnishi Oda	General

Item	Management Office	Address / Tel. / Fax / E-mail	Contact	Related document
Bar Code System	Neonet Inc. EDMS Dept.	12F World Trade Center Bldg., 2-4-1 Hamamatsu-cho, Minato-ku, Tokyo 105-6112, Japan Tel: +81-3-6430-3193 Fax: +81-3-6430-3196 E-mail: edms@neonet-inc.jp	Suzuki Kamiie	02-4-2
Ceiling Construction	Makuhari Messe, Inc. Convention Affairs Sect.	2-1, Nakase, Mihama-ku, Chiba-shi, Chiba Prefecture 261-0023, Japan Tel: +81-43-296-0602 Fax: +81-43-296-0529	Takada Fujiwara	04-1-4
Booth Display, Hazardous Items, Floor Work, Temporary Telephone Service, Rental Furniture, Package Booth(s)	Murayama Inc.	2-13-10, Koraku, Bunkyo-ku, Tokyo 112-0004, Japan Tel: +81-3-3813-1202 Fax: +81-3-3813-1274 E-mail: interbee@murayama.co.jp	Iisawa Norose Yamazaki	04-2-1 04-2-3 04-5-1 05-2-1 05-3-2
Electrical Work	Shoho Denki Co., Ltd.	1-28-15, Kamiikebukuro, Toshima-ku, Tokyo 170-0012, Japan Tel: +81-3-3918-7993 Fax: +81-3-3918-7800 E-mail: interbee@shohodenki.co.jp	Hatano Suzuki	04-2-5
	Suzuki Denki Co., Ltd.	2-12-15, Hanakawado, Taito-ku, Tokyo 111-0033, Japan Tel: +81-3-3842-8201 Fax: +81-3-3845-3040 E-mail: eigyobu@suzukidenki.co.jp	Iida Sekiya	
Bonded Goods, Loading Work on the Show Site, Move-in and Move-out Work (in Japan)	Ishikawa-Gumi, Ltd.	5-9-4, Higashi-Shinagawa, Shinagawa-ku, Tokyo 140-0002, Japan Tel: +81-3-3474-8102 Fax: +81-3-5460-9841 E-mail: igl-exhi@ishikawa-gumi.co.jp	Hasegawa	04-3-1
			Saito	05-1-1
Internet Connection	Makuhari Messe, Inc. Information Machine Room	2-1, Nakase, Mihama-ku, Chiba-shi, Chiba Prefecture 261-0023, Japan Tel: +81-43-296-0493 Fax: +81-43-296-0492	Takauchi	04-4-3
			Otsuka	05-3-1

Inquiries List

Item	Management Office	Address / Tel. / Fax/ E-mail	Contact	Related document
Antenna Installation	Makuhari Messe, Inc. Information Machine Room	2-1, Nakase, Mihama-ku, Chiba-shi, Chiba Prefecture 261-0023, Japan Tel: +81-43-296-0536 Fax: +81-43-296-0012 E-mail: messe@tfvc.jp	Shishikura Uga	05-3-3
Accommodation	Nippon Travel Agency Co., Ltd. Chiba Branch	4F, Chiba Center Square Bldg. 2-3-16 Chuo, Chuo-ku, Chiba-shi, Chiba 260-0013 Japan Tel: +81-43-227-2307 Fax: +81-43-225-2241 Email: ibee_2010@nta.co.jp	Nakao Mukasa	05-4-1
Meal Ticket	Makuhari Messe, Inc. Accounting and Management Sect.	2-1, Nakase, Mihama-ku, Chiba-shi, Chiba Prefecture 261-0023, Japan Tel: +81-43-296-0525 Fax: +81-43-296-0529		05-4-2
Catering Service for Booths	Nilax Inc.	2-1 Nakase Mihama-ku, Chiba-shi, Chiba 261-0023, Japan TEL: +81-43-296-0512 FAX: +81-43-296-2003	Hori	05-2-3
Lunch box Delivery Service	Wako Sangyo Inc.	5-38-3, Kyodo, Setagaya-ku, Tokyo 156-0052, Japan Tel: +81-3-3427-8331 Fax: +81-3-3427-8332	Sano	05-4-3
Receptionist interpreters	Ken & Staff Co., Ltd.	YKS Bldg, 4-14-7, Takadanobaba, Shinjuku-ku, Tokyo 169-0075, Japan Tel: +81-3-3367-0020 Fax: +81-3-3367-0027	Fujita	05-4-4
Booth photography	Kurano Photo Office	860-54, Higashifukai, Nagareyama-shi, Chiba 270-0101, Japan Tel: +81-471-55-3806 Fax: +81-471-55-3806 E-mail: y.kurano@nifty.com	Kurano Umemura	05-4-5
Cleaning Booth	Chibaken Bldg-Maintenance Corp. c / o Makuhari Messe, Inc.	2-1, Nakase, Mihama-ku, Chiba-shi, Chiba Prefecture 261-0023, Japan Tel: +81-43-296-0534 Fax: +81-43-296-0753 E-mail: cbm-sato@bz01.plala.or.jp	sato	05-4-6
Copyright Royalties	Japan Society for Rights of Authors, Composers and Publishers (JASRAC) Tokyo Event / Concert Branch Office	10th Floor, Nihon Seimei Shinjuku Nishiguchi Bldg., 1-17-1, Nishi Shinjuku, Shinjuku-ku, Tokyo 160-0023, Japan Tel: +81-3-5321-9881 Fax: +81-3-3345-5760		04-4-2